

artigo

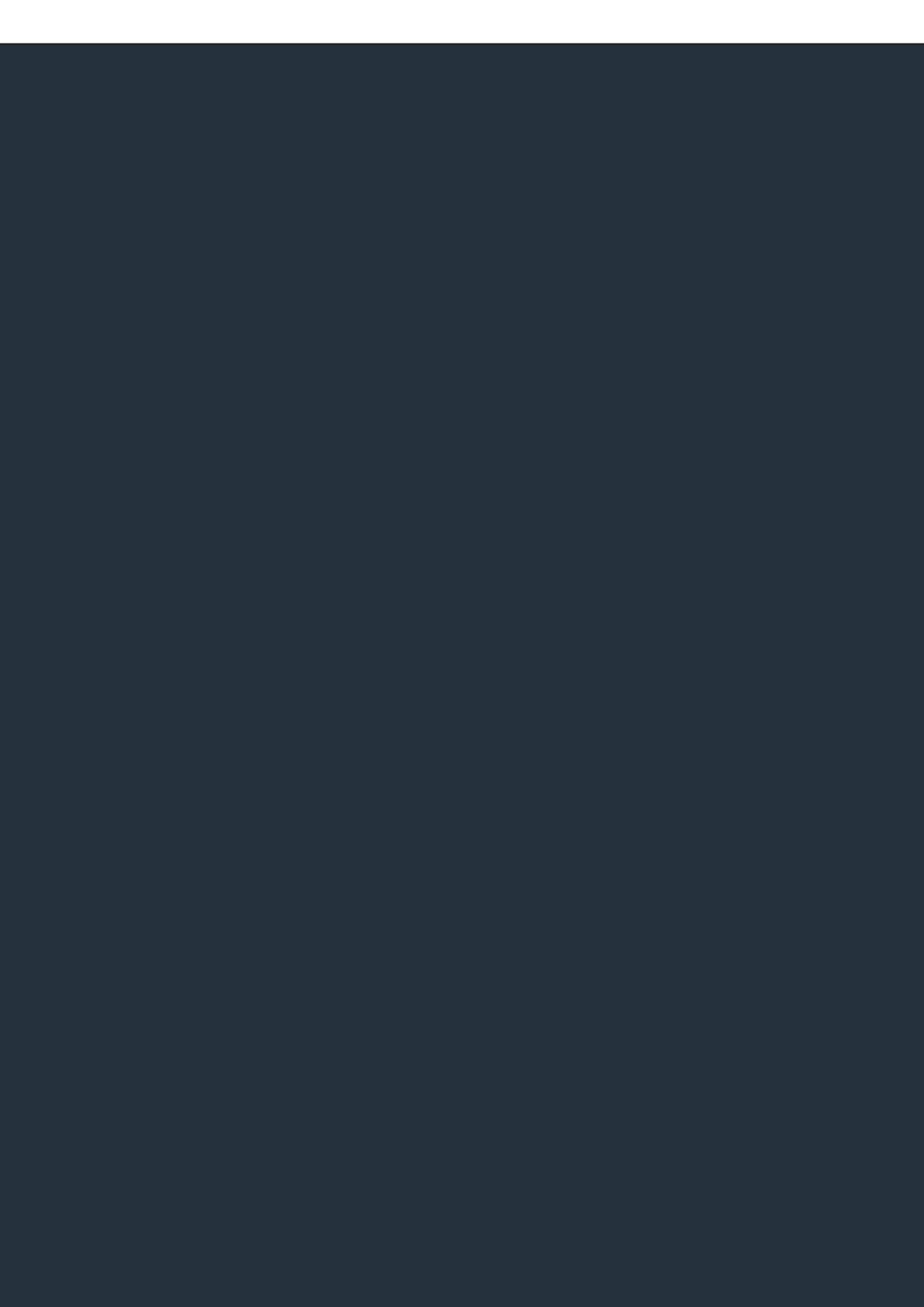

## Artigo: la tecnologia dei pavimenti in gomma

La gomma: una materia prima con caratteristiche uniche di resistenza ed elasticità, trasformata e ingegnerizzata in un'ampia collezione di pavimenti ad alte prestazioni. Proposte innovative che nascono dall'unione di due realtà: Artigo, con il proprio patrimonio di ricerca iniziato all'interno del gruppo Pirelli negli anni '20 e Mondo, fondata nel 1948 e protagonista internazionale nel campo delle applicazioni della gomma in ambito commerciale e sportivo. Dall'incontro di due culture industriali, una collezione ampia e diversificata, che trova un'eccezionale varietà di applicazioni.

Rubber is a raw material that has unique stress-resistance and elasticity characteristics, suitable for producing a wide range of high-performance flooring. Innovative products that stem from the partnership of Artigo, with its research work that began within the Pirelli Group in the 1920's, and Mondo, established in 1948 and world leader in rubber applications for business and the sports industry. The coming together of two industrial cultures has produced a vast and diverse collection, with an exceptional number of different applications.

Le caoutchouc: une matière première aux propriétés de résistance et d'élasticité unique, transformée et traitée industriellement, elle offre un choix de revêtements de sol de hautes performances. Des propositions innovantes issues de l'union de deux savoirs faire: Artigo l'inventeur de la dalle à pastilles devenu dès les années 20, le département sols caoutchouc du groupe Pirelli, et Mondo fondée en 1948 célèbre pour ses réalisations sur les secteurs commerciaux et sportifs. Cette rencontre de deux cultures industrielles a donné naissance à une collection riche, diversifiée offrant un exceptionnel potentiel créatif.

Kautschuk: Ein Rohstoff mit einzigartigen Eigenschaften in puncto Beständigkeit und Elastizität wurde in eine umfangreiche Kollektion von Bodenbelägen mit leistungsstarken Eigenschaften verwandelt. Eine innovative Angebotsvielfalt als Ergebnis aus der Zusammenarbeit zweier Unternehmen: Artigo, mit seiner eigenen wissenschaftlichen Tradition, die in den 1920er Jahren innerhalb der Pirelli-Gruppe ihren Ausgang nahm, und Mondo, ein 1948 gegründetes, international agierendes Unternehmen im Bereich Kautschukbeläge für gewerbliche und sportliche Zwecke. Durch das Zusammentreffen zweier industrieller Kulturen entstand eine umfangreiche, breitgefächerte Kollektion für eine außergewöhnliche Anwendungsvielfalt.

La goma: una materia prima con características únicas de resistencia y elasticidad, transformada y producida en una amplia selección de pavimentos de altas prestaciones. Propuestas innovadoras que nacen de la unión de dos realidades: Artigo, con su propio patrimonio de investigación iniciado dentro del grupo Pirelli en los años 20 y Mondo, fundada en 1948 y protagonista internacional en el campo de las aplicaciones de la goma en el ámbito comercial y deportivo. Del encuentro de dos culturas industriales, nace una colección amplia y diversificada, que encuentra una excepcional variedad de aplicaciones.



Prodotto	Ambienti	Colori	Caratteristiche
Product	Interiors	Colours	Specifications
Produit	Intérieurs	Couleurs	Caractéristiques
Produkt	Ambiente	Farben	Eigenschaften
Producto	Ambientes	Colores	Características

## PLANSYSTEM

<b>KAYAR</b>	7/9	34	66
<b>MULTIFLOOR / ND - UNI</b>	13	36	66
<b>GRANITO</b>	19/21	38	66
<b>GRAIN</b>	15	40	66
<b>MULTIFLOOR / ND - NAT</b>	25	42	66

## SPECIALS

<b>KAYAR / LL</b>		44	67
<b>UNI / LL</b>	29	45	67
<b>GRANITO / ANT 48</b>	27	46	66
<b>GRANITO ELASTIC</b>		46	66
<b>ZEUS / ANT 48</b>		47	67
<b>GEODE COND</b>		47	66

## STUDSYSTEM

<b>ZERO.4</b>	5	48	67
<b>BS</b>	17	50	67
<b>EBONY</b>	11	52	67
<b>ARDESIA</b>		53	67
<b>ZEUS</b>	23	54	67
<b>ROLLFLOOR</b>		56	

## STAIRSYSTEM

<b>FULLSTEP</b>	31	58	
<b>ROLLSTEP</b>		59	
<b>accessories</b>		60/65	

## Sottsass Associati: la gomma come materiale creativo

Nell'infinita libertà creativa offerta dalle pavimentazioni in gomma, la continua ricerca Artigo è sfociata in una collaborazione con lo studio Sottsass Associati. Un incontro che ha portato alla definizione di nuovi progetti che coniugano innovazione tecnologica e massima performance funzionale, proponendo inediti accostamenti di materiali. Alla base di ognuna delle proposte c'è l'idea di un manufatto industriale che si appropria della casualità di un processo naturale: la fibra di cocco in Kayar; il pattern di distribuzione apparentemente casuale di Zero.4; l'astrazione concettuale di Ebony. Attraverso interventi sulla materia o sulla forma, è sempre una "piccola casualità" l'elemento che caratterizza e accomuna le superfici.

The boundless creative freedom typical of rubber flooring and Artigo's ongoing research have led to collaboration with the firm Sottsass Associati. This convergence has brought about the definition of new projects that combine technological innovation and ultimate functional performance by proposing original material blends. Each of the proposals is based on the idea of an industrial artefact that takes possession of a natural process and random feature: Kayar coconut fibre, Zero.4's apparently random distribution pattern, and Ebony's conceptual abstraction. The surfaces' typical common element is always a "small random event" produced by interventions on matter and form.

La liberté créative infinie que permet le caoutchouc et la volonté constante d'innovation d'Artigo ont abouti naturellement à une collaboration avec le cabinet Sottsass Associati. Une rencontre qui a conduit à la définition de nouveaux sols alliant innovation, technologie, performance fonctionnelle maximale, et proposant des associations inédites de matériaux. À la base de chaque proposition il y a l'idée d'un produit industriel qui bénéficie du caractère fortuit d'un processus naturel: le coir, soit la fibre de coco pour le Kayar, la distribution et le diamètre apparemment aléatoire des pastilles pour Zero.4; l'abstraction conceptuelle d'Ebony. Quand on travaille la matière ou la forme, il y a toujours une "petite dose de hasard", l'élément commun qui caractérise nos sols.

In der unendlichen kreativen Freiheit, die Kautschukbeläge bieten, hat die kontinuierliche Forschungsarbeit von Artigo eine Zusammenarbeit mit dem Studio Sottsass Associati mit sich gebracht. Eine Begegnung, die zur Definition neuer Projekte geführt hat, in denen sich technologische Innovation und maximale funktionelle Leistungsmerkmale vereinen und völlig neue Materialkombinationen präsentiert werden. Hinter jedem Angebot steckt die Idee eines industriellen Artefakts, das sich die Zufälligkeit eines natürlichen Prozesses zu eigen macht: die Kokosfaser aus Kayar; das scheinbar zufällige Verteilungsmuster von Zero.4; die begriffliche Abstraktion von Ebony. Durch Eingriffe an Material oder Form ist immer eine "kleine Zufälligkeit" das gemeinsame Element, das die Oberflächen kennzeichnet.

En la infinita libertad creativa que ofrecen los pavimentos de goma, la continua investigación de Artigo ha desembocado en una colaboración con el estudio Sottsass Associati. Un encuentro que ha llevado a la definición de nuevos proyectos que conjugan innovación tecnológica y máximo rendimiento funcional, ofreciendo combinaciones inéditas de materiales. En la base de cada una de las propuestas, se encuentra la idea de un producto industrial que se apropia de la casualidad de un proceso natural: la fibra de coco en Kayar; el patrón de distribución aparentemente aleatorio de Zero.4; la abstracción conceptual de Ebony. A través de intervenciones en la materia o en la forma, siempre es una "pequeña casualidad" el elemento que caracteriza y une las superficies.



## Una scelta ecologica

La gomma è ottenuta dal caucciù, estratto da alberi che non vengono danneggiati dal processo, oppure dalle code di produzione delle benzine. In entrambi i casi, la realizzazione di un pavimento in gomma non comporta la distruzione o il consumo di risorse e non produce sostanze fortemente inquinanti. Al termine della sua lunghissima “vita”, una pavimentazione in gomma è assimilabile ad un rifiuto solido urbano e di facile smaltimento. Le pavimentazioni Artigo rispondono inoltre alle più rigorose specifiche ambientali: si possono fregiare delle più importanti certificazioni ecologiche europee (come BRE e BLUE ANGEL) e contribuiscono all’ottenimento dei crediti LEED.

Rubber is either obtained from trees, which are not damaged by the process, or from the residue of petrol production. In both cases, the manufacture of rubber flooring does not involve the destruction or the consumption of resources and does not produce highly toxic substances. At the end of its very long “life”, rubber flooring resembles solid urban waste and is, hence, easy to dispose of. Artigo flooring conforms to the most rigorous environmental standards and boasts some of Europe’s most important environmental certifications (from BRE and BLUE ANGEL for example), which helps to obtain LEED credits.

Le caoutchouc est obtenu à partir du caoutchouc naturel, extrait d’arbres qui ne sont pas endommagés par le processus, ou des queues de production de l’essence. Dans les deux cas, la réalisation d’un sol en caoutchouc n’entraîne pas la destruction ou la consommation de ressources, et ne produit pas de substances fortement polluantes. Au terme de sa très longue « vie », un sol en caoutchouc est assimilable à un déchet solide urbain, facile à éliminer. Les revêtements de sol Artigo sont conformes aux normes les plus sévères en matière d’environnement: nous pouvons nous enorgueillir d’avoir obtenu les principales certifications écologiques européennes (comme BRE et BLUE ANGEL) qui contribuent à l’obtention des crédits LEED.

Entweder wird Bäumen Naturkautschuk entnommen, die bei diesem Verfahren allerdings nicht beschädigt werden, oder es entsteht aus den Produktionsprozessen für Benzin. In beiden Fällen ist die Herstellung eines Fußbodens aus Kautschuk nicht mit der Zerstörung oder dem Verbrauch von Ressourcen verbunden und erzeugt auch keine stark umweltbelastenden Substanzen. Am Ende seines langen „Lebens“ kann ein Kautschukbelag dem Hausmüll zugefügt und leicht entsorgt werden. Die Bodenbeläge von Artigo entsprechen zudem den strengsten Umweltauflagen: Sie erhielten sehr wichtige europäische ökologische Zertifizierungen (wie die BRE-Zertifizierung und das Umweltzeichen Blauer Engel) und tragen zum Erreichen von LEED-Punkten bei.

La goma se obtiene del caucho, extraído de árboles que durante el proceso no sufren daños o de los procesos de producción de las gasolinas. En ambos casos, la realización de un pavimento de goma no conlleva la destrucción o el consumo de recursos y no produce sustancias con un alto nivel de contaminación. Al término de su larguísima “vida”, un pavimento de goma es asimilable a un residuo sólido urbano y es fácil de eliminar. Los pavimentos Artigo responden también a las más rigurosas especificaciones medioambientales: poseen las certificaciones ecológicas europeas más importantes (como BRE y BLUE ANGEL) y contribuyen a la obtención de los créditos LEED.









## Tecnologia esclusiva

Artigo è in grado di proporre una serie di finiture superficiali esclusive per i propri pavimenti, concepite per proteggere ulteriormente ogni tipo di realizzazione. I trattamenti superficiali garantiscono una maggiore resistenza alle macchie e agli agenti chimici, permettendo di ridurre considerevolmente l'utilizzo di detersivi, acqua ed energia necessari per la manutenzione. Il risparmio si traduce anche in un ulteriore vantaggio economico se si considera l'ottimo impatto sul ciclo di vita del prodotto. Un'innovazione che contribuisce sensibilmente alla salvaguardia ambientale delle risorse.

Exclusive technology. Artigo has a range of exclusive surface finishes for its flooring, designed to offer further protection for every application. The surface treatments guarantee an even better resistance to staining and chemical agents, considerably reducing the level of detergents, water and energy required for maintenance. This also means even greater savings considering the excellent impact on the product's lifecycle. This innovative feature helps to protect environmental resources.

Technologie exclusive. Artigo est en mesure de proposer toute une série de finitions exclusives pour la surface de ses sols, conçues pour mieux protéger tout type de réalisation. Les traitements de surface garantissent une meilleure résistance aux taches et aux agents chimiques, ce qui permet de réduire considérablement l'emploi de produits détergents, l'eau et les énergies nécessaires à l'entretien. Une réduction qui se traduit notamment par un autre avantage économique si l'on considère l'excellent impact sur le cycle de vie du produit. Une innovation qui contribue de manière significative à la sauvegarde des ressources de l'environnement.

Exklusive Technologie. Artigo bietet eine Reihe von exklusiven Oberflächenvergütungen für seine Bodenbeläge an, die jeden Belagstyp noch besser schützen. Die Oberflächenbehandlungen garantieren eine größere Beständigkeit gegen Flecken und Chemikalien und ermöglichen dadurch eine beträchtliche Einsparung von Reinigungs- und Pflegemittel, sowie Wasser und Energie für die Instandhaltung. Diese Einsparung bringt noch einen weiteren wirtschaftlichen Vorteil mit sich, wenn man die hervorragende Auswirkung auf den Lebenszyklus des Produkts berücksichtigt. Eine Innovation, die erheblich zum Schutz der Umwelt und ihrer Ressourcen beiträgt.

Tecnología exclusiva. Artigo es capaz de ofrecer una serie de acabados superficiales exclusivos para sus pavimentos, diseñados para proteger aún más cada instalación. Los tratamientos superficiales garantizan una mayor resistencia a las manchas y a los agentes químicos, de modo que permiten reducir considerablemente el uso de detergentes, agua y energía necesarios para el mantenimiento. El ahorro se traduce también en una ventaja económica adicional si se considera el óptimo impacto sobre el ciclo de vida del producto. Una innovación que contribuye notablemente a la protección medioambiental de los recursos.

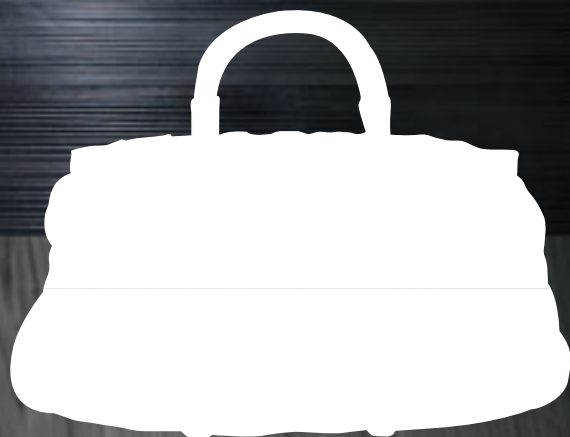

## Unico come la gomma

Una serie di caratteristiche “uniche” fanno della gomma la scelta ottimale per tutti i luoghi pubblici e privati ad alta frequentazione. Altissima resistenza all’usura e alle bruciature di sigaretta: situazioni di traffico molto elevato quali ospedali, università, aeroporti, cinema, centri commerciali, possono usufruire di un materiale che garantisce una durata di vita eccezionale. La permanente elasticità della gomma la rende estremamente resistente agli urti e le permette di “recuperare” la sua forma anche dopo essere stata sottoposta a grandi pressioni.

Unique like rubber. A series of “unique” specifications make rubber the best choice for high traffic public and private areas. Very high resistance to wear and cigarette burns: high-traffic situations such as in hospitals, universities, airports, cinemas, shopping centres require the use of a material with an exceptional life span. The permanent elasticity of rubber makes it extremely resistant to shocks and enables it to “recover” its shape even after undergoing high pressures.

Unique comme le caoutchouc. Une série de caractéristiques “ uniques ” font du caoutchouc le choix idéal pour tous les lieux publics et privés à passage intense. Très grande résistance à l’usure et aux brûlures de cigarette : les situations de passage très intense telles que dans les hôpitaux, universités, aéroports, cinémas, centres commerciaux, peuvent bénéficier d’un matériau qui garantit une longévité exceptionnelle. L’élasticité permanente du caoutchouc le rend extrêmement résistant aux chocs et lui permet de “ récupérer ” sa forme même après avoir été soumis à de grandes pressions.

Einzigartig wie Kautschuk. Eine Reihe einzigartiger Eigenschaften machen Kautschuk zur optimalen Wahl für alle öffentlichen und privaten Räume mit hoher Besucherfrequenz. Sehr hohe Resistenz gegen Abnutzung und glühende Zigarettensammel: In Situationen sehr hohen Besucheraufkommens wie in Krankenhäusern, Universitäten, Flughäfen, Kinos, Einkaufszentren, ist dieses Material, das eine lange Lebensdauer garantiert, sehr nützlich. Die permanente Elastizität des Kautschuk macht es extrem widerstandsfähig gegen Stöße und ermöglicht dem Boden eine Wiedererholung seiner Form, auch nachdem er großem Druck ausgesetzt wurde.

Único como la goma. Una serie de características “únicas” hacen de la goma la elección ideal para todos los lugares públicos y privados muy frecuentados. Altísima resistencia al desgaste y a las quemaduras de cigarrillos: situaciones de tráfico muy elevado como hospitales, universidades, aeropuertos, cines, centros comerciales, pueden disfrutar de un material que garantiza una excepcional duración. La permanente elasticidad de la goma la hace extremadamente resistente a los golpes y le permite “recuperar” su forma incluso después de haber sufrido grandes presiones.









## Igienici per natura

Quando l'igiene degli ambienti è un requisito fondamentale, la gomma si dimostra un materiale dalle caratteristiche ideali. Una pavimentazione in gomma è una superficie compatta ed ermetica, il rivestimento viene fatto "risalire" lungo le pareti, eliminando l'angolo di battuta con il pavimento: non vi si possono quindi depositare residui o formare colonie batteriche. Le giunzioni vengono sigillate a caldo, permettendo una disinfezione completa del rivestimento. Grazie ai trattamenti superficiali PRO e TXL, la manutenzione risulta ancora più semplice e veloce, con un sempre più ridotto dispendio di risorse energetiche.

Hygienic by nature. When the hygiene of interiors is a crucial requirement, rubber proves to be the ideal material. Rubber flooring is a dense and sealed surface. The covering can continue up along the walls, thereby eliminating any joints with the floor: neither dirt nor bacteria can therefore deposit or form. All joints can be heat-sealed for total surface disinfection. The PRO and TXL surface treatments ensure easy and quick maintenance, considerably reducing energy expenditure.

Hygiéniques par nature. Lorsque l'hygiène des environnements est une exigence fondamentale, le caoutchouc est le matériau aux caractéristiques idéales. Un sol en caoutchouc est une surface compacte et étanche; afin d'éliminer l'angle murs-sol, on fait remonter le revêtement le long des murs: ainsi les résidus ne peuvent pas s'y déposer ou former des colonies bactériennes. Les jonctions sont scellées à chaud, permettant une désinfection complète du revêtement. Grâce aux traitements de surface PRO et TXL, l'entretien est encore plus simple et rapide, avec une consommation de ressources énergétiques de plus en plus réduite.

Hygiene von Natur aus. Wenn es in manchen Bereichen vor allem auf Hygiene ankommt, ist Kautschuk ein Material mit idealen Eigenschaften. Ein Fußbodenbelag aus Kautschuk besitzt eine kompakte und hermetisch abgeschlossene Oberfläche. Der Boden kann als Wandhochzug verlegt werden, und dadurch kann eine Fuge bei der Wand vermieden werden: Folglich kann sich dort kein Schmutz ablagern und es können keine Bakterienkolonien entstehen. Die Fugen können verschweißt werden und erlauben eine komplette Desinfektion des Belags. Dank der Oberflächenausführungen PRO und TXL ist die Reinigung noch einfacher und schneller möglich, und der Energieverbrauch wird reduziert.

Higiénicos por naturaleza. Cuando la higiene de los ambientes es un requisito fundamental, la goma resulta ser un material con características ideales. Un pavimento en goma es una superficie compacta y hermética, el revestimiento se hace "subir" a lo largo de las paredes, eliminando el ángulo entre la pared y el pavimento: por lo tanto no se depositan residuos y no se forman colonias bacterianas. Las juntas se sellan en caliente, permitiendo una desinfección completa del revestimiento. Gracias a los tratamientos superficiales PRO y TXL, el mantenimiento resulta todavía más sencillo y rápido, con un siempre más reducido derroche de recursos de energías.



## Rinnovare, innovare

Luoghi che cambiano utilizzo, destinazione e tipo di utenti in tempi brevi e con grande frequenza: una tipologia d'installazione in cui la gomma offre prestazioni superiori. Caratteristiche funzionali quali la leggerezza, lo spessore contenuto (da un minimo di 2 mm), la rapidità di posa, la facilità di manutenzione e la possibilità di copertura di pavimentazioni preesistenti, senza doversi preoccupare del loro recupero, ne fanno un ottimo prodotto per il rinnovo di edifici esistenti.

Renovating, innovating. Areas that change function and type of user quickly and very frequently: a type of installation where rubber provides superior performance. Functional characteristics such as light weight, reduced thickness (from minimum 2 mm), fast installation, easy maintenance and the possibility of covering pre-existing floors, without having to worry about refurbishing them, make rubber an excellent product for renovating existing buildings.

Rénover, innover. Lieux qui changent d'utilisation, de destination et de type d'utilisateurs en peu de temps et très fréquemment : une typologie d'installation où le caoutchouc offre des performances supérieures. Des caractéristiques fonctionnelles telles que la légèreté, l'épaisseur limitée (d'un minimum de 2 mm), la rapidité de pose, la facilité d'entretien et la possibilité de couvrir d'anciens sols, sans devoir se préoccuper de leur récupération, en font un excellent produit pour la rénovation d'édifices existants.

Renovieren, erneuern. Räume, deren Verwendung, Zweckbestimmung und Benutzertyp sich in kurzer Zeit und großer Häufigkeit ändern: Bedingungen, unter denen Kautschuk außergewöhnliche Leistungen bietet. Funktionale Eigenschaften wie wenig Gewicht, reduzierte Dicke des Belags (ab 2mm), schnelles Verlegen, einfache Pflege und die Möglichkeit bestehende Fußbodenbeläge abdecken zu können, ohne sich um die Probleme von deren Wiederherstellung kümmern zu müssen, machen aus Kautschuk ein exzellentes Produkt zur Renovierung bestehender Gebäude.

Renovar, innovar. Lugares que cambian su uso, destino y tipo de usuarios en cortos plazos y con gran frecuencia: una tipología de instalación en la que la goma ofrece prestaciones superiores. Características funcionales como la ligereza, el reducido espesor (desde un mínimo de 2 mm), la rapidez de colocación, la facilidad de mantenimiento y la posibilidad de cobertura de pavimentos preexistentes, sin tenerse que preocupar de su recuperación, hacen que sean un producto ideal para la renovación de edificios ya existentes.



## Le caratteristiche chimiche

Le pavimentazioni in gomma Artigo sono composte da gomme naturali e sintetiche, cariche minerali rinforzanti e pigmenti coloranti naturali scelti fra le sostanze che non causano impatto sull'ambiente, durante il processo produttivo e il ciclo di vita del pavimento. Non contengono: pvc, metalli pesanti, alogeni (cloro, bromo, fluoro, iodio), amianto, formaldeide (marchio CE), cadmio, plastificanti volatili e sono quindi assimilabili ai rifiuti solidi urbani. La ridotta emissione di VOC (composti organici volatili) è certificata secondo le severe norme Tedesche e Americane.

Chemical specifications. Artigo rubber flooring is made of both natural and synthetic rubber, reinforcing mineral charges and natural colour pigments selected from substances that remain environment-friendly during the floor's production process and life cycle. They do not contain: PVC, heavy metals, halogens (chlorine, bromine, fluorine, iodine), asbestos, formaldehyde (EC brand), cadmium, volatile plasticizers and are, therefore, similar to solid urban waste. The low emission of VOC (volatile organic compounds) has been certified in accordance with strict German and American regulations.

Les caractéristiques chimiques. Les revêtements de sol en caoutchouc Artigo sont composés de caoutchoucs naturels et synthétiques, de charges minérales de renforcement et de pigments colorants naturels choisis parmi les substances sans impact sur l'environnement, durant le processus de production et le cycle de vie du sol. Ils ne contiennent pas de : PVC, métaux lourds, halogènes (chlore, brome, fluor, iode), amiante, formaldéhyde (marquage CE), cadmium, plastifiants volatils, ils sont par conséquent assimilables aux déchets solides urbains. L'émission réduite de COV (composés organiques volatils) est certifiée selon les sévères normes allemandes et américaines.

Die chemischen Eigenschaften. Die Fußbodenbeläge aus Kautschuk Artigo bestehen aus natürlichem und synthetischem Kautschuk, verstärkt mit mineralischen Anteilen und natürlichen Farbpigmenten, die aus erlesenen Substanzen selektiert wurden, damit sie sowohl während des Produktionsprozesses als auch der gesamten Lebensdauer des Fußbodens umweltfreundliche Eigenschaften aufweisen. Das Material enthält keinerlei PVC, Schwermetalle, Halogene (Chlor, Brom, Fluor, Jod), Asbest, Formaldehyd (EG-Handelsmarke), Cadmium, flüchtige Weichmacher und kann daher dem Hausmüll zugeführt werden. Die geringe Emission von VOCs (flüchtige organische Bestandteile) wurde gemäß der strengen deutschen und amerikanisch Vorschriften zertifiziert.

Las características químicas. Los pavimentos en goma Artigo están compuestos por gomas naturales y sintéticas, cargas minerales fortalecedoras y pigmentos colorantes naturales elegidos entre las sustancias que no causan impacto en el ambiente, durante el proceso productivo y el ciclo de vida del pavimento. No contienen: pvc, metales pesados, halógenos (cloro, bromo, flúor, yodo), amianto, formaldehído, cadmio, plastificantes volátiles y por lo tanto son asimilables a los residuos sólidos urbanos. La emisión reducida de VOC (compuestos orgánicos volátiles) ha sido certificada según las severas normas Alemanas y Americanas.



ERGENCY







## Comfort di marcia

Nelle situazioni ad alto traffico, le pavimentazioni Artigo si rivelano una scelta ottimale anche per quanto riguarda il comfort dei frequentatori: per esempio, la gomma conferisce alle superfici un considerevole abbattimento acustico del rumore dovuto al calpestio, raggiungendo valori di riduzione fino a 20 db. Ma non solo: la gomma sviluppa meno di 2000 volt di elettricità statica, ed evita quindi la formazione delle fastidiose scariche avvertibili dalle persone al contatto con parti metalliche. Infine, l'elasticità di questo materiale permette un comfort al camminamento particolarmente importante negli edifici con lunghe percorrenze.

Walking comfort. In highly-trafficked areas, Artigo flooring are an excellent choice for walking comfort too: for example, rubber ensures considerable reduction of noise due to treading, achieving reduction values of up to 20 db. But that is not all: rubber develops less than 2000 Volts of static electricity and thus prevents the formation of the annoying discharges that occur following contact with metal parts. Finally, the elasticity of this material ensures a high degree of walking comfort in buildings with long corridors.

Confort de marche. Dans les situations à passage intense, les revêtements de sol Artigo se révèlent un choix optimal même en ce qui concerne le confort des usagers : par exemple, un revêtement de sol en caoutchouc permet de réduire considérablement le bruit provoqué par le passage, les valeurs de réduction peuvent atteindre 20 db. Mais ce n'est pas tout : le caoutchouc développe moins de 2000 volts d'électricité statique, permettant ainsi d'éviter la formation des décharges désagréables que les personnes peuvent ressentir au contact de parties métalliques. Enfin, l'élasticité de ce matériau permet un confort de marche particulièrement important dans les édifices avec de longs parcours.

Komfort. Bei hoher Besucherfrequenz erweisen sich die Fußbodenbeläge Artigo auch in Hinblick auf den Gehkomfort als eine optimale Wahl: Zum Beispiel erreicht Kautschuk auch eine beachtliche Trittschallverbesserung, die bis zu einem Wert von 20 dB herankommen kann. Mehr noch: Kautschuk entwickelt beim Begehen weniger als 2000 Volt elektrostatische Aufladung und vermindert somit lästige Entladungen, denen Personen beim Kontakt mit Metallteilen ausgesetzt sind. Schließlich ermöglicht die Elastizität dieses Materials ein hohes Maß an Gehkomfort insbesondere bei Gebäuden mit langen Korridoren.

Confort de marcha. En las situaciones de alto tráfico, los pavimentos Artigo resultan ser una elección ideal también con respecto al confort de los usuarios: por ejemplo, la goma confiere a las superficies una considerable reducción acústica del ruido debido a la pisada, alcanzando valores de reducción hasta los 20 db. Pero no sólo eso: la goma desarrolla menos de 2000 voltios de electricidad estática, y evita así la formación de las molestas descargas que las personas sienten al contacto con partes metálicas. En fin, la elasticidad de este material permite un confort al andar, hecho particularmente importante en los edificios con largos recorridos.



## Tutti gli aspetti della sicurezza

Il risultato di una ricerca che persegue la massima sicurezza su tutti i fronti. Sicurezza contro gli incendi: i pavimenti Artigo rispondono a tutte le norme internazionali di reazione al fuoco e ai requisiti delle principali norme ferroviarie. In particolare, la gomma garantisce una bassa opacità e tossicità dei fumi in caso d'incendio. Sicurezza nei confronti degli utenti: i pavimenti Artigo superano i parametri richiesti dalle norme internazionali per la prevenzione degli infortuni e per l'abbattimento delle barriere architettoniche in ambienti pubblici e sui luoghi di lavoro.

All safety aspects. The result of research centred on achieving maximum all-round safety. Safety against fires : Artigo flooring comply with all international fire-reaction regulations and with the requirements of major railway regulations. In particular, rubber provides low opacity and toxicity of fumes in case of fire. Safety for users: Artigo flooring exceed the parameters required by international standards for the prevention of accidents and the elimination of obstacles to the disabled in public areas and working places.

Tous les aspects de la sécurité. Le résultat d'une recherche qui poursuit la sécurité maximale sur tous les fronts. Sécurité contre les incendies : les revêtements de sol Artigo répondent à toutes les normes internationales de réaction au feu et aux exigences des principales normes ferroviaires. Le caoutchouc garantit notamment une faible opacité et toxicité des fumées en cas d'incendie. Sécurité à l'égard des usagers : les revêtements de sol Artigo dépassent les paramètres requis par les normes internationales pour la prévention des accidents et vont au delà des règles architecturales dans les lieux publics et sur les lieux de travail.

Alle Sicherheitsaspekte. Das Ergebnis einer Forschung, die maximale Sicherheit an allen Fronten anstrebt. Sicherheit im Brandfall: Die Fußböden Artigo entsprechen allen internationalen Normen des Brandverhaltens und den Anforderungen für öffentliche Verkehrsmittel. Insbesondere garantiert Kautschuk im Brandfall eine niedrige Rauchdichte und Rauchtotoxicität. Sicherheit in Hinsicht auf die Benutzer: Die Fußböden von Artigo übertreffen die Anforderungen der internationalen Standards für Unfallvermeidung, sie sind behindertengerecht in öffentlichen und Arbeitsbereichen.

Todos los aspectos de la seguridad. El resultado de una investigación que persigue la máxima seguridad en todos los aspectos. Seguridad contra los incendios: los pavimentos Artigo cumplen con todas las normas internacionales de reacción al fuego y los requisitos de las principales normas ferroviarias. En particular, la goma garantiza una baja opacidad y toxicidad de los humos en caso de incendio. Seguridad hacia los usuarios: los pavimentos Artigo superan los parámetros requeridos por las normas internacionales para la prevención de los accidentes y para la reducción de las barreras arquitectónicas en ambientes públicos y en los lugares de trabajo.



ected Area



ESD Protected Area







## Una gamma di prodotti completa

La gamma di pavimenti Artigo, tutta certificata con marchio CE, comprende anche prodotti conformi a specifiche e stringenti normative. Artigo Marine è una linea di prodotti certificati IMO ed adatti all'impiego in campo navale, mentre nel settore ferroviario speciali mescole ignifughe garantiscono gli alti standard di sicurezza richiesti per questo tipo di applicazione. Il range dei prodotti non si ferma alle pavimentazioni ma comprende anche un'ampia gamma di elementi complementari e "specifici" per la finitura degli ambienti. Le scale sono il completamento ideale di ogni progetto, soprattutto per quanto riguarda i locali pubblici. Artigo propone due sistemi: Fullstep, per gradini a spigolo vivo e Rollstep, per gradini arrotondati.

A complete product range. The Artigo flooring range, which is CE certified, also comprises products that comply with strictly specific regulations. Artigo Marine is an IMO certified product range that is ideal for the marine sector, while special fire-retardant compounds guarantee the high safety standards demanded by the railway sector for such applications. The range of Artigo products does not end with the presented floors but also comprises a broad selection of complementary and "specific" elements designed to add a finishing touch to environments. Stairs ideally complete any project, especially when it comes to public areas. Artigo presents two systems: Fullstep, for sharp-edge steps and Rollstep, for rounded steps.

Une gamme complète de produits. La gamme de sols Artigo, entièrement certifiée par le marquage CE, comprend également des produits conformes à des normes spécifiques et rigoureuses. Artigo Marine est une ligne de produits certifiés IMO et adaptés à l'emploi dans le secteur naval, tandis que dans le secteur ferroviaire des mélanges ignifuges spéciaux garantissent les hauts standards de sécurité requis pour ce type d'application. La gamme des produits ne se limite pas aux revêtements de sol, mais comprend également un vaste choix d'éléments complémentaires et « spécifiques » pour la finition des environnements. Les escaliers sont le complément idéal de chaque projet, surtout en ce qui concerne les établissements publics. Artigo propose deux systèmes : Fullstep, pour marches à arête vive, et Rollstep, pour marches arrondies.

Eine komplette Produktpalette. Die Palette der Fußbodenbeläge Artigo, die alle gemäß EG-Vorschrift zertifiziert sind, umfasst auch Erzeugnisse, die speziellen, strengen Vorschriften entsprechen. Artigo Marine ist eine Produktlinie mit IMO-Zertifikat für den Einsatz im Bereich der Schifffahrt, während im Eisenbahnsektor spezielle feuerhemmende Mischungen die für diesen Anwendungsbereich geforderten hohen Standards gewährleisten. Die Palette der Artigo-Produkte beschränkt sich nicht auf die Fußbodenbeläge, sondern beinhaltet auch eine große Auswahl an zusätzlichen und "speziellen" Elementen zur Vervollständigung der Ambiente. Die Treppenstufen sind das ideale Zubehör für jedes Projekt, vor allem in öffentlichen Räumen. Artigo bietet dazu zwei Systeme: Fullstep, für Stufen mit scharfen Kanten und Rollstep, für abgerundete Stufen.

Una gama de productos completa. La gama de pavimentos Artigo, toda certificada con marca CE, también comprende productos conformes a requisitos y normativas específicas. La Artigo Marine es una línea de productos certificados IMO y adecuados al empleo en campo naval, mientras que en el sector de ferrocarriles especiales mezclas ignífugas que garantizan los altos estándares de seguridad requeridos para este tipo de aplicaciones. La gama de productos Artigo no termina con los pavimentos presentados sino que incluye también una amplia elección de elementos complementarios y "específicos" para el acabado de los ambientes. Las escaleras son el complemento ideal de cada proyecto, sobre todo con respecto a los locales públicos. Artigo propone dos sistemas: Fullstep, para peldaños de arista aguda y Rollstep, para peldaños redondeados.





**Legenda simboli**  
**Key to symbols**  
**Légende symboles**  
**Erklärung der Symbole**  
**Leyenda símbolos**



Resistenza allo scivolamento  
 Slip resistance  
 Résistance au glissement  
 Rutschhemmung  
 Resistencia al deslizamiento



Euroclasse di reazione al fuoco  
 Euro class of fire reaction  
 Euro class de comportement au feu  
 Brandverhalten Euroklasse  
 Euroclase de reacción al fuego



Antistatico  
 Antistatic  
 Antistatique  
 Antistatisch  
 Antiestático

**Legenda trattamenti**  
**Key to treatments**  
**Légende**  
**Erklärung Oberflächenausführung**  
**Leyenda de los tratamientos**



**GRAIN**  
**GRANITO**  
**KAYAR**  
**KAYAR LL**  
**MULTIFLOOR / ND - NAT**  
**MULTIFLOOR / ND - UNI**  
**UNI LL**



**BS CLASSIC**  
**BS STRONG**  
**GRANITO ELASTIC**  
**ZERO.4**  
**ZEUS**



standard

**ARDESIA**  
**BN**  
**EBONY**  
**GEODE COND**  
**GRANITO / ANT48**  
**RIGATO**  
**ROLLFLOOR BR**  
**ROLLFLOOR BN**  
**ZEUS / ANT 48**

**Diagramma dei costi di manutenzione**  
**Diagram of maintenance costs**  
**Diagramme des coûts de maintenance**  
**Diagramm der Pflegekosten**  
**Diagrama de los costes de manutención**

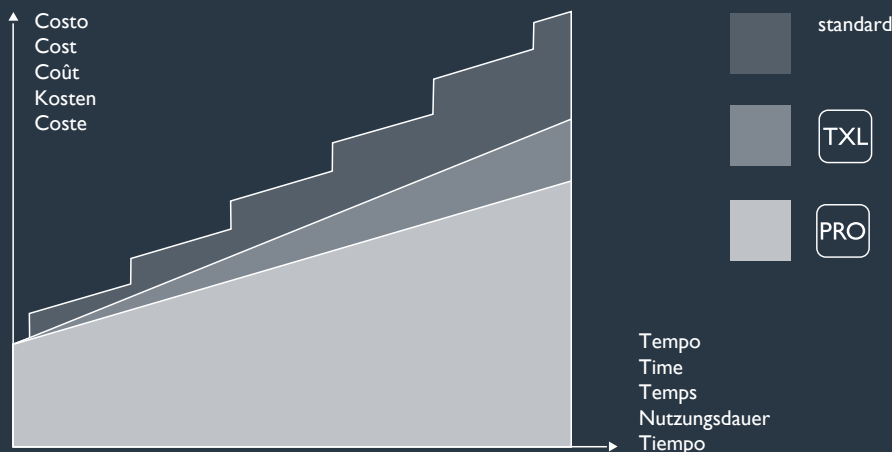

**Finitura PRO**  
**PRO finish**  
**Finition PRO**  
**PRO Oberflächenvergütung**  
**Acabado PRO**

Trattamento superficiale realizzato tramite spalmatura di coating polimerico di ultima generazione fissato con reticolazione UV. La copertura polimerica protegge la superficie migliorandone le performance riducendo gli interventi di pulizia e manutenzione.

A surface treatment utilising the latest generation UV linked polymeric coating technology. The coating finish protects the surface, improves performance and reduces the need for cleaning and maintenance.

Traitement de la surface réalisé par enduisage d'un coating de polymères de la dernière génération fixé avec réticulation UV. La couverture polymérique protège la surface, en améliorant les performances et en réduisant les opérations de nettoyage et entretien.

Oberflächenbehandlung, bei der eine Polymervergütung der letzten Generation aufgebracht und UV- vernetzt wird. Die Vergütung schützt die Oberfläche, verbessert die Widerstandsfähigkeit und reduziert Pflege- und Reinigungskosten.

Tratamiento superficial realizado a través de la aplicación del coating polimerico de última generación fijado con reticulación UV. La cobertura polimérica protege la superficie mejorando la performance reduciendo las operaciones de limpieza y mantención.

**Vantaggi del trattamento PRO rispetto al pavimento tradizionale**

- Ottima protezione da sporco e graffi
- Migliore resistenza a macchie ed agenti chimici
- Non è necessaria la ceratura (ad eccezione delle aree ad alto traffico, come ulteriore protezione)
- Facilità di pulizia e manutenzione
- Risparmio di acqua, detersivi ed energia
- Ottimo impatto economico sul ciclo di vita del prodotto
- Ridotta emissione di TVOC

**Advantages of PRO treatment compared with standard flooring**

- High protection against dirt and scratches
- Enhanced resistance to stains and chemical agents
- No further wax/polishing necessary (except for added protection in very high traffic areas)
- Easier cleaning and maintenance
- Saving in water, detergents and energy
- Excellent economical impact on lifecycle cost
- Lower TVOC emission

**Avantages du traitement PRO par rapport au sol traditionnel**

- Excellente protection de la saleté et des égratignures
- Résistance meilleure aux taches et aux agents chimiques
- Pas de cirage (à l'exception de zones à passage intense comme ultérieur protection)
- Facilité de nettoyage et entretien
- Economie d'eau, détergents et énergie
- Excellent résultat économique sur le cycle vital du produit
- Emissions réduites d'après TVOC test

**Vorteile der PRO Oberflächenvergütung im Vergleich mit Standardbodenbelägen**

- Hoher Schutz gegen Schmutz und Zerkratzen
- Bessere Widerstandsfähigkeit gegen Flecken und chemische Substanzen
- Einlassen ist nicht notwendig (nur zum zusätzlicher Schutz in extrem beanspruchten Bereichen)
- Leichtere Reinigung und Pflege
- Einsparung von Wasser, Reinigungsmittel und Energie
- Kosteneinsparung über den gesamten Lebenszyklus des Bodenbelags
- Geringere Emission von flüchtigen organischen Verbindungen (VOC)

**Ventajas del tratamiento PRO respecto al pavimento tradicional**

- Óptima protección de la suciedad y rasguños
- Mejor resistencia a las manchas y agentes químicos
- No es necesario el encerado (excepto en zonas de alto tráfico, como ulterior protección)
- Facilidad de limpieza y mantención
- Ahorro de agua, detergentes y energía
- Óptimo impacto económico en el ciclo de vida del producto
- Reducida emisión de TVOC

**Finitura TXL**  
**TXL finish**  
**Finition TXL**  
**TXL Oberflächenverdichtung**  
**Acabado TXL**

Trattamento superficiale di postvulcanizzazione che incrementa la resistenza e densità superficiale. La minor porosità della superficie ne migliora la pulibilità e la resistenza allo sporco.

Post vulcanization treatment that achieves a lower surface density whilst increasing surface resistance, enhancing cleaning, dirt and scratch resistant properties.

Traitement superficiel de post vulcanisation qui augmente la résistance et la densité de la surface. La moindre porosité de la surface améliore le nettoyage et la résistance à la saleté.

Postvulkanisationsbehandlung, welche die Dichte und Widerstandsfähigkeit der Oberfläche erhöht. Eine niedrigere Oberflächenporosität verbessert Reinigungs- und Anschmutzverhalten.

Tratamiento superficial de postvulcanización que incrementa la resistencia y densidad superficial. La menor porosidad de la superficie mejora la limpieza y la resistencia a la suciedad.

**Vantaggi del trattamento TXL rispetto al pavimento tradizionale**

- Maggiore protezione da sporco e graffi
- Non è necessaria la ceratura per applicazioni soggette a manutenzione regolare con utilizzo di monospazzola
- Facilità di pulizia e manutenzione
- Risparmio di acqua, detersivi ed energia
- Buon impatto economico sul ciclo di vita del prodotto

**Advantages of TXL treatment compared with standard flooring**

- Enhanced protection against dirt and scratches
- No further wax/polishing necessary in low traffic areas
- Easier cleaning and maintenance
- Saving in water, detergents and energy
- Appreciable economical impact on lifecycle cost.

**Avantages du traitement TXL par rapport au sol traditionnel**

- Protection meilleure de la saleté et des égratignures
- Cirage non pas nécessaire en cas d'entretien régulier avec mono brosse.
- Facilité de nettoyage et entretien
- Economie d'eau, détergents et énergie
- Excellent résultat économique su le cycle vital du produit

**Vorteile der TXL Oberflächenverdichtung im Vergleich mit Standardbodenbelägen**

- Besserer Schutz gegen Schmutz und Zerkratzen
- Einlassen ist in Bereichen mit niedriger Frequenz nicht notwendig, wenn mit Einscheibenmaschinen u. ähnliches regelmäßig gereinigt wird
- Leichtere Reinigung und Pflege
- Einsparung von Wasser, Reinigungsmittel und Energie
- Merkbare Kostenersparnis über den gesamten Lebenszyklus des Bodenbelags

**Ventajas del tratamiento TXL respecto al pavimento tradicional**

- Mayor protección a la suciedad y a los rasguños
- No es necesario el encerado para aplicaciones sometidas a mantención regular de utilización de mono-escoba
- Facilidad de limpieza y mantención
- Ahorro de agua, detergentes y energía
- Buen impacto económico sobre el ciclo de vida del producto

Superficie liscia con fibre naturali.  
 Smooth surface with natural fibers.  
 Surface lisse avec fibres naturelles.  
 Glatte Oberfläche mit Naturfasern.  
 Superficie lisa con fibras naturales.



610 x 610 mm



1,90 x 10 m



4,9 kg/m²



Classificazione / Classification UPEC U<sub>4</sub> P<sub>3</sub> E<sub>2</sub> C<sub>1</sub>



K 72



K 38

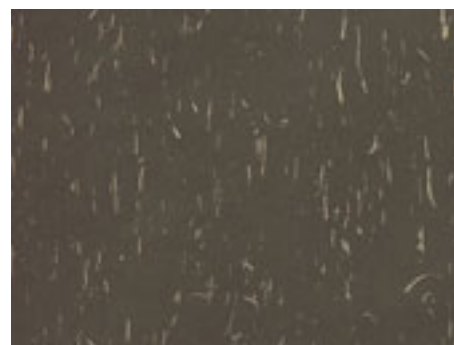

K 39



K 71

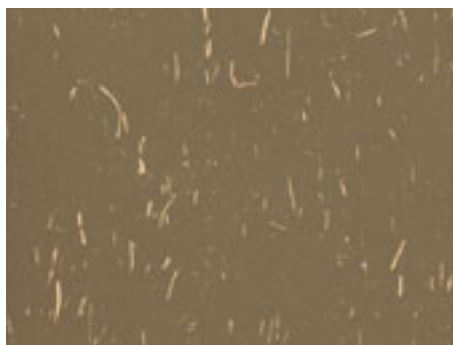

K 48



K 64



K 74



K 63



K 62



K 70



K 102

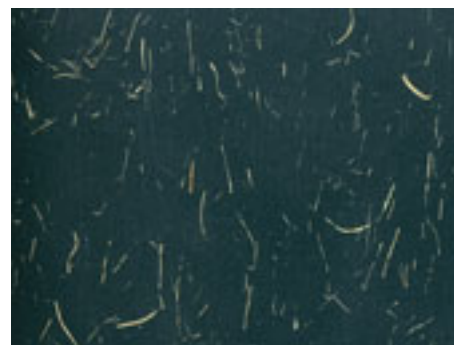

K 61



K 17



K 27



K 52



K 21

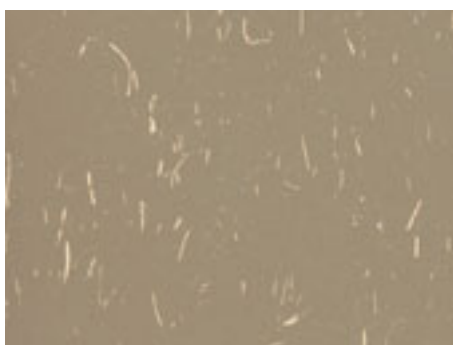

K 58



K 73



K 01



K 54



K 104

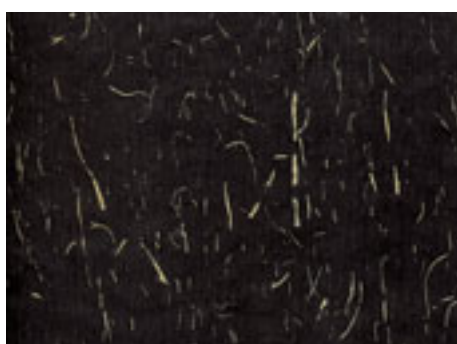

K 00



K 103



K 49

Superficie liscia in tinta unita.  
 Smooth surface in solid colours.  
 Surface lisse en teinte unie.  
 Glatte Oberfläche in einfarbiger Version.  
 Superficie lisa en color único.

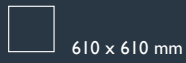

Classificazione / Classification UPEC **U<sub>4</sub> P<sub>3</sub> E<sub>2</sub> C<sub>1</sub>**



U 108 Canary



U 107 Lime

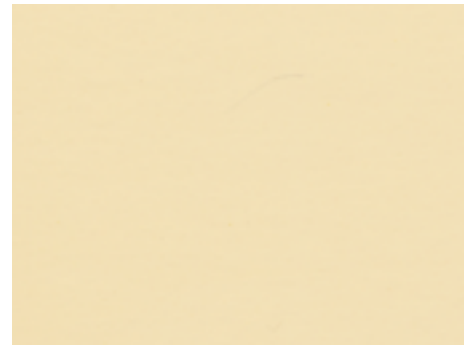

U 87 Cream



U 11 Gold



U 106 Bamboo



U 27 Sand



U 105 Tangerine

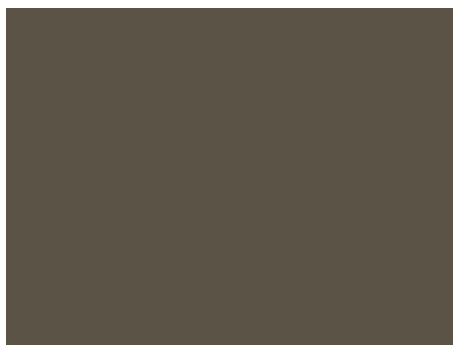

U 39 Olive

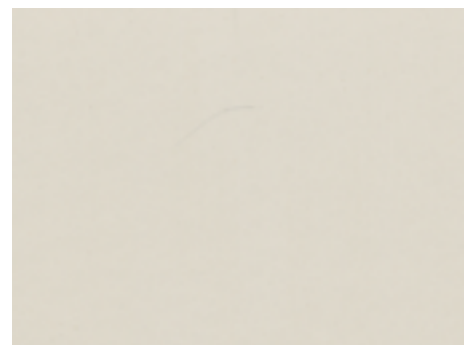

U 99 Ice

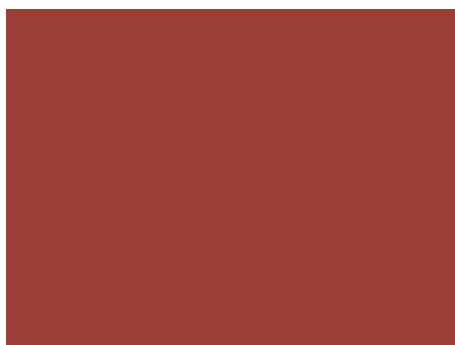

U 13 Firebrik

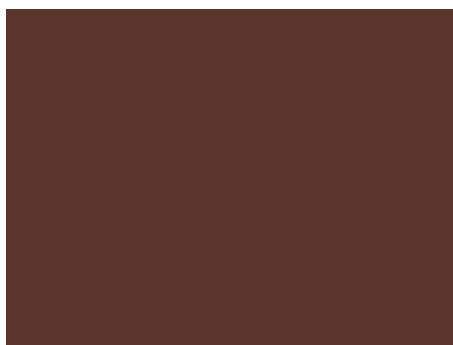

U 14 Mahogany



U 36 Silk



U 109 Pearl



U 20 Smoke



U 17 Metal



U 54 Greige



U 26 Steel



U 21 Eiffel



U 55 Stone



U 16 Avio

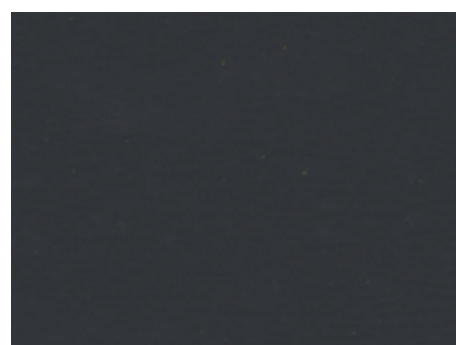

U 110 Slate



U 56 Navajo



U 18 Grape



U 00 Carbon

Superficie liscia con finissimi grani multicolori.  
 Smooth surface with multicoloured granules.  
 Surface lisse avec de très fins granules multicolores incorporés.  
 Glatte Oberfläche mit sehr feiner verschiedenfarbiger Körnung.  
 Superficie lisa con pequeñas partículas multicolores.



Classificazione / Classification UPEC U<sub>4</sub> P<sub>3</sub> E<sub>2</sub> C<sub>1</sub>



G 363

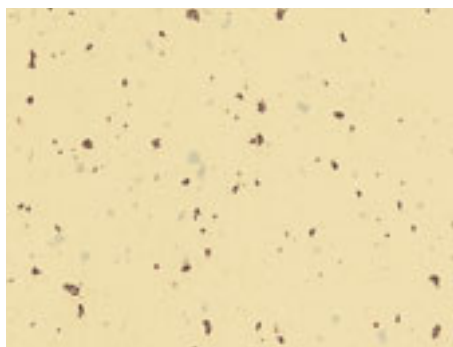

G 315



G 370

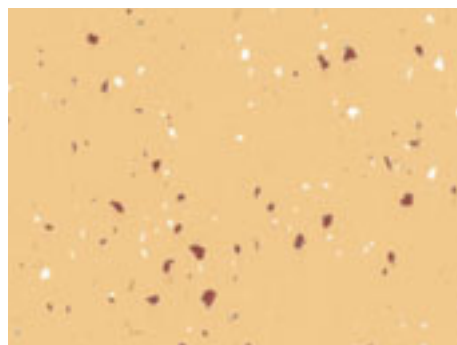

G 365

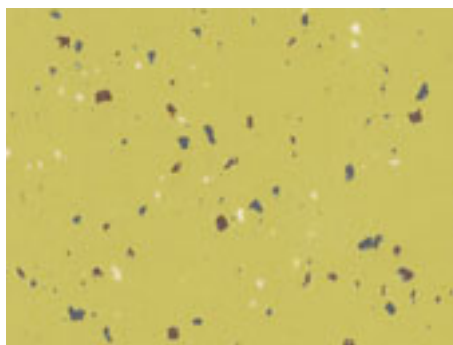

G 473

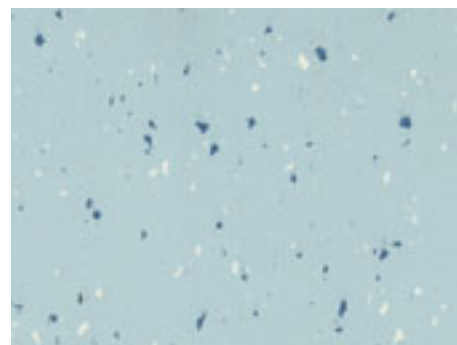

G 371



G 472



G 378

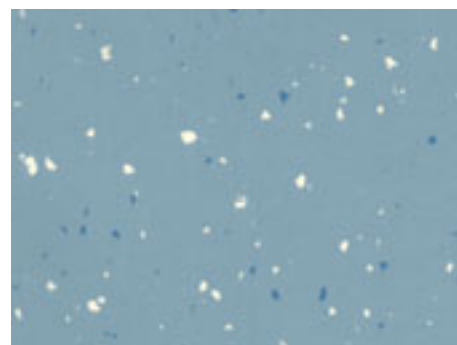

G 372



G 367

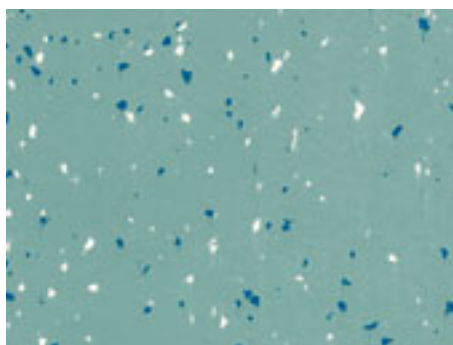

G 336

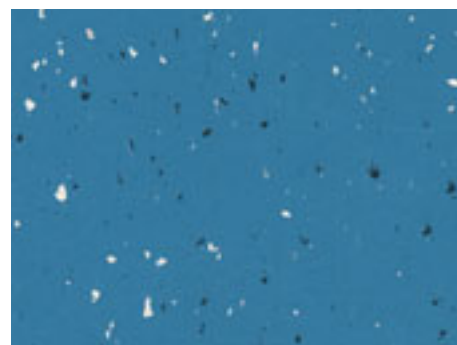

G 342



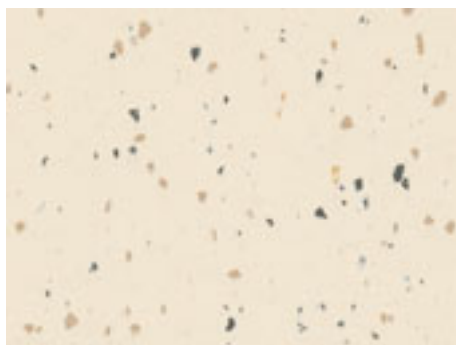

G 479



G 431



G 480

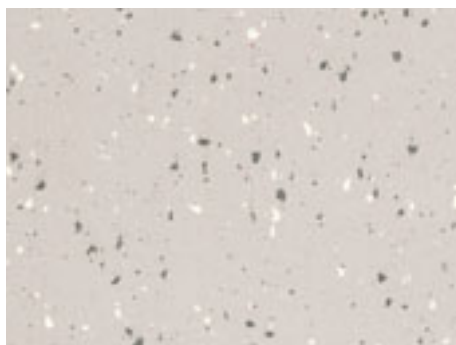

G 368

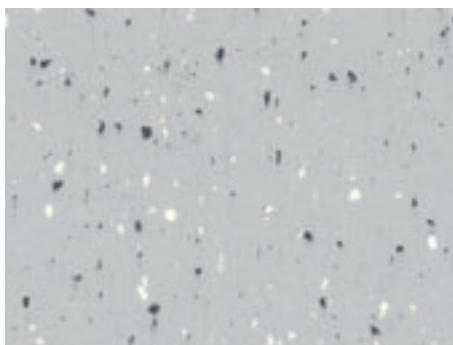

G 305

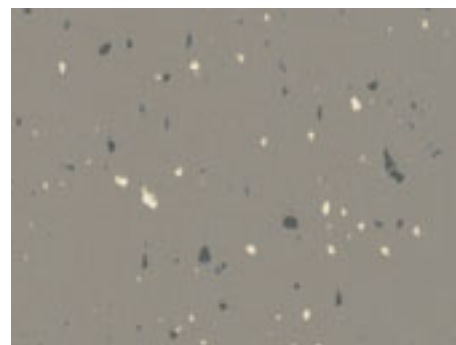

G 478



G 475



G 306

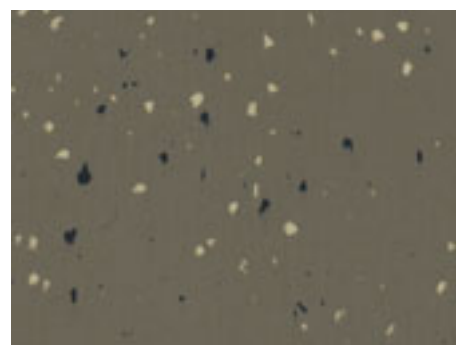

G 477

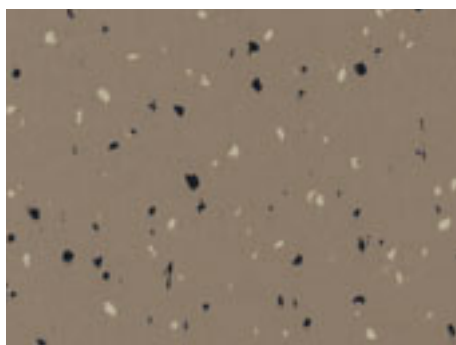

G 474

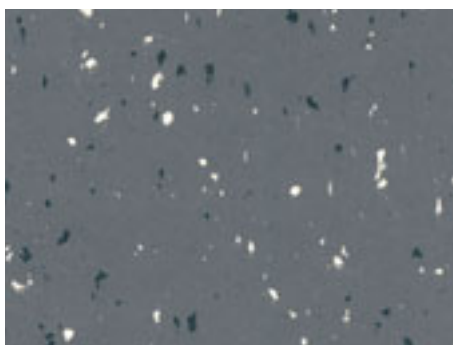

G 308

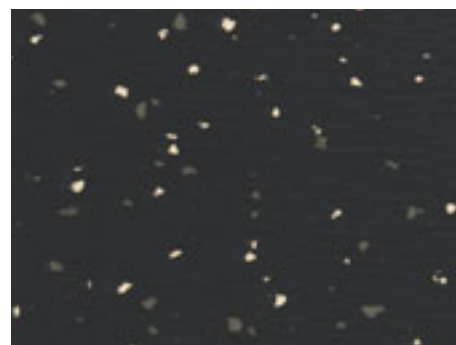

G 476

Superficie liscia con grani multicolori.  
 Smooth surface with multicoloured granules.  
 Surface lisse avec de granules multicolores incorporés.  
 Glatte Oberfläche mit verschiedenfarbiger Körnung.  
 Superficie lisa con partículas multicolores.



3,0 mm



610 x 610 mm



1,90 x 10 m



4,8 kg/m<sup>2</sup>



HG 105



HG 106



HG 115



HG 111

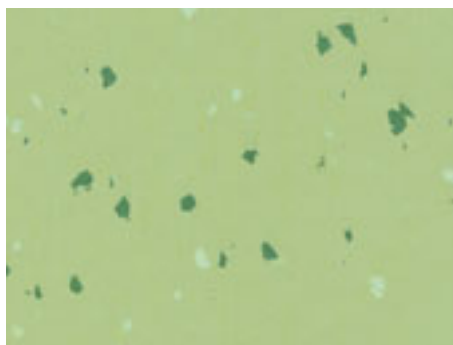

HG 114



HG 116



HG 109

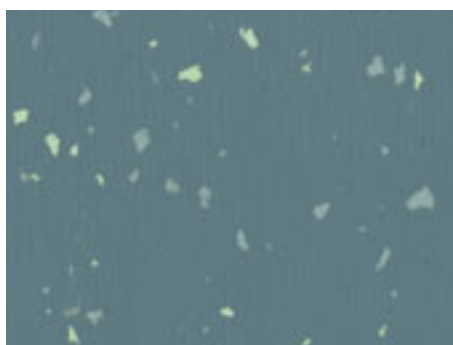

HG 112



HG 113

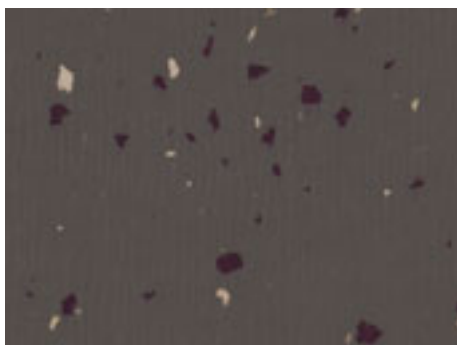

HG 110



HG 118

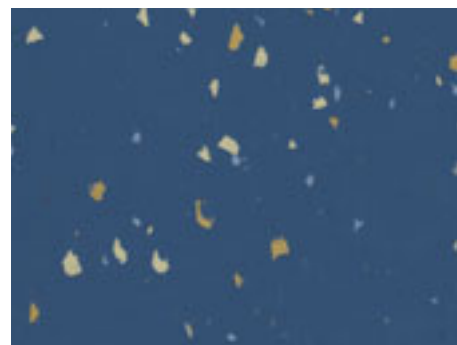

HG 107



HG 120



HG 100



HG 104



HG 103



HG 123

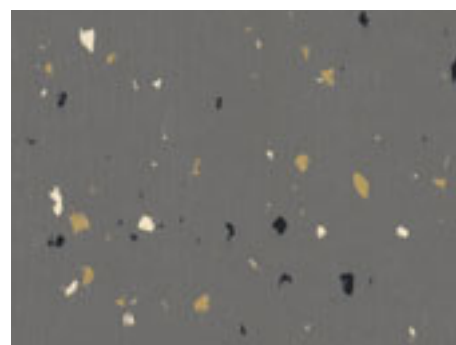

HG 119

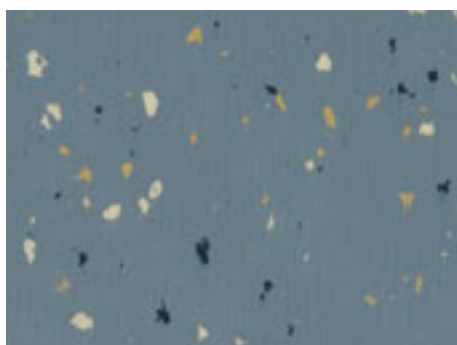

HG 117



HG 101

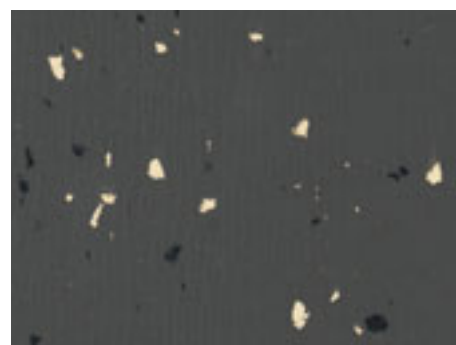

HG 108



HG 121



HG 102

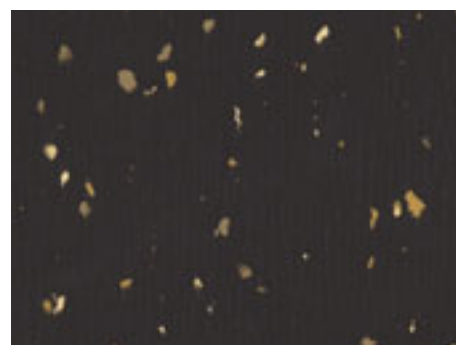

HG 122

Superficie liscia con marmorizzazione a più colori.  
 Smooth surface marbled in more colours.  
 Surface lisse marbrée de plusieurs couleurs.  
 Glatte Oberfläche mit mehrfarbiger Marmorierung.  
 Superficie lisa con marmolizado de varios colores.



Classificazione / Classification UPEC U<sub>4</sub> P<sub>3</sub> E<sub>2</sub> C<sub>1</sub>



M 33 Cappuccino



M 11 Fog



M 08 Beige



M 37 Acquamarina



M 34 Ambra

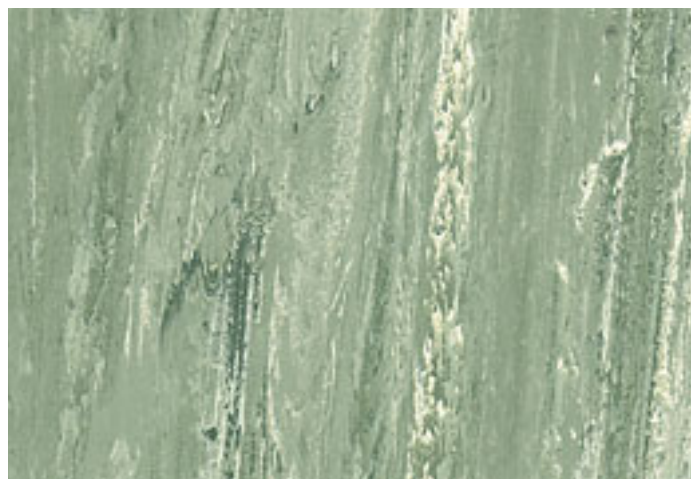

M 15 Green

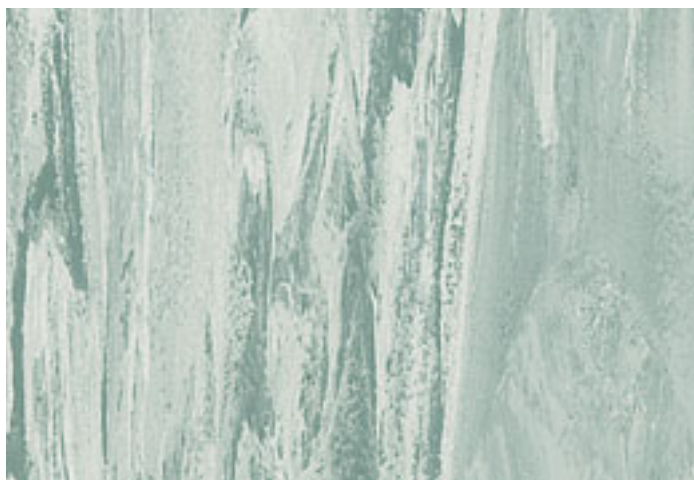

M 38 Iceberg



M 20 Smoke



M 39 Cloud



M 02 Stone



M 19 Jeans

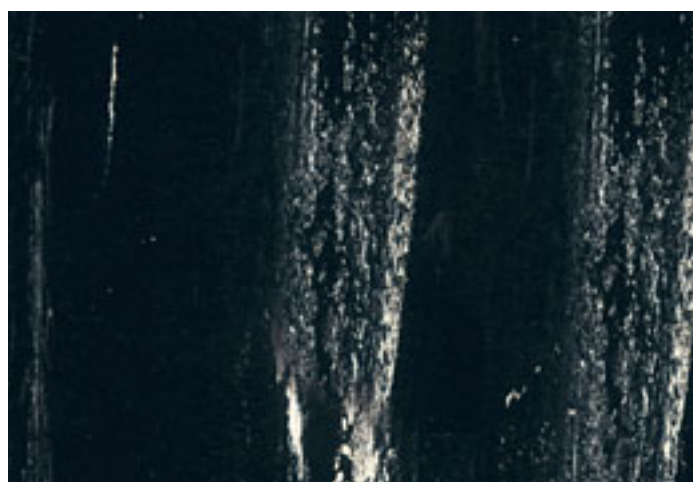

M 00 Carbon

Autoposante. Superficie liscia con fibre naturali.  
 Loose lay. Smooth surface with natural fibers.  
 Autoportant. Surface lisse avec fibres naturelles.  
 Zur losen Verlegung. Glatte Oberfläche mit Naturfasern.  
 Autoposante. Superficie lisa con fibras naturales.



5,0 mm



610 x 610 mm



8,6 kg/m<sup>2</sup>



K 73



K 104



K 54

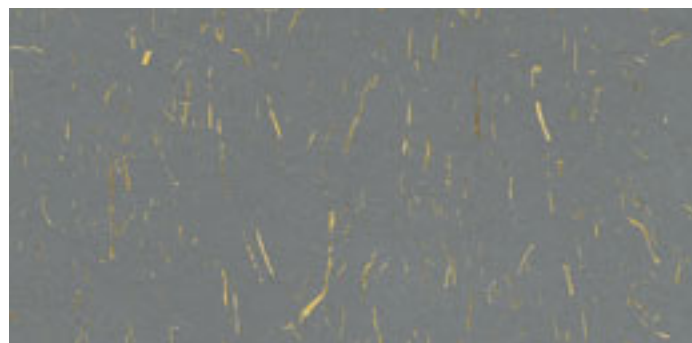

K 17



K 103

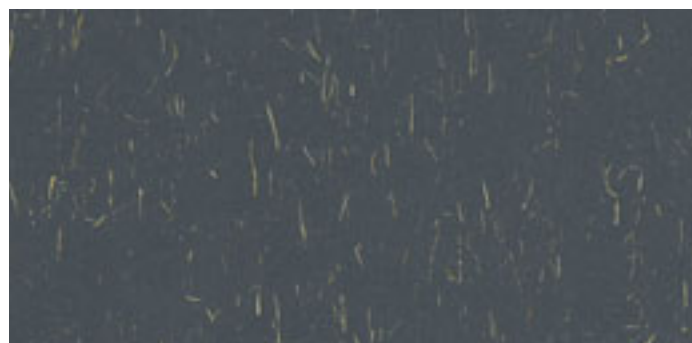

K 21



K 72



K 01

Autoposante. Superficie liscia in tinta unita.  
 Loose lay. Smooth surface in solid colour.  
 Autoportant. Surface lisse en teinte unie.  
 Zur losen Verlegung. Glatte Oberfläche in einfarbiger Version.  
 Autoposante. Superficie lisa en color único.

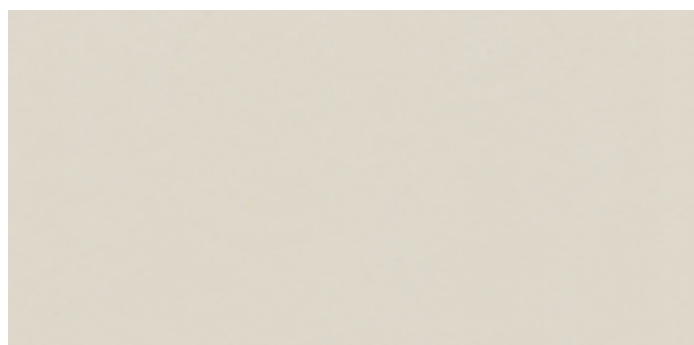

U 99



U 54



U 27



U 17



U 55



U 21



U 105



U 00

Pavimento dissipativo. Superficie gofrata.  
 Dissipative flooring. Embossed surface.  
 Revêtement de sol dissipateur. Surface gaufrée.  
 Ableitfähige Bodenbeläge. Reflexbrechende Oberfläche.  
 Pavimento dissipativo. Superficie gofrada.

Pavimento acustico (20dB). Superficie gofrata.  
 Acoustic flooring (20dB). Embossed surface.  
 Revêtement acoustique (20dB). Surface gaufrée.  
 Trittschallschutz (20dB). Reflexbrechende Oberfläche.  
 Pavimento acústico (20dB). Superficie gofrada.



G 479



G 479



G 480



G 480



G 305

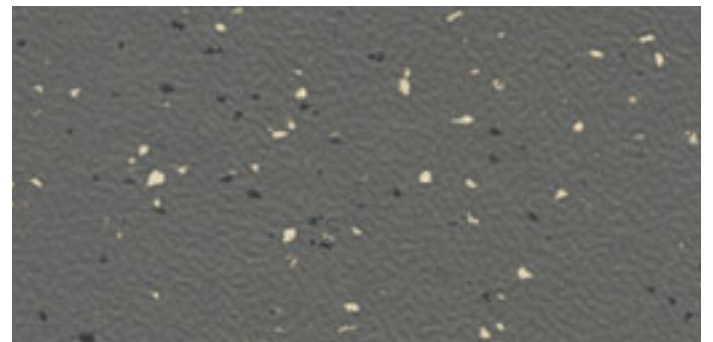

G 308

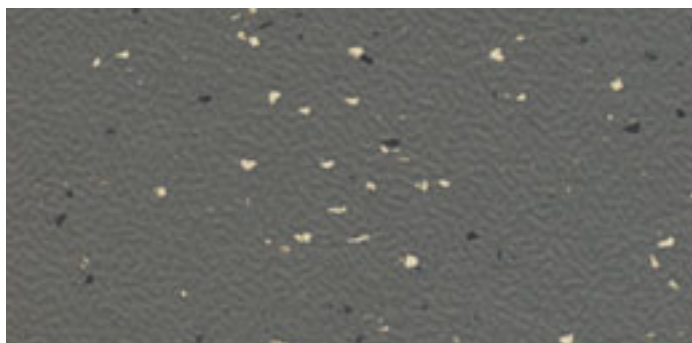

G 308

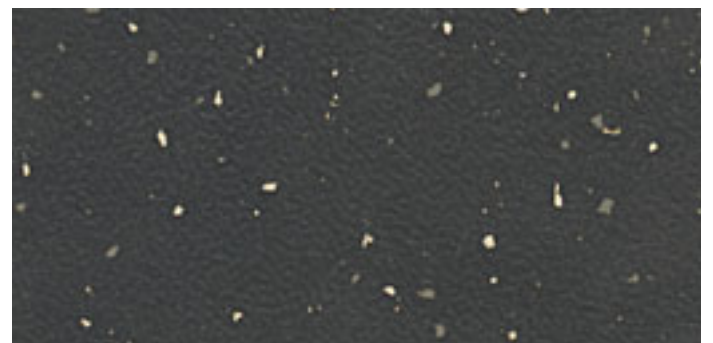

G 476



Pavimento conduttivo. Superficie gofrata.  
 Conductive flooring. Embossed surface.  
 Revêtement de sol conducteur. Surface gaufrée.  
 Leitfähig Bodenbeläge. Reflexbrechende Oberfläche.  
 Pavimento conduttivo. Superficie gofrada.

Pavimento dissipativo. Superficie martellata multicolore.  
 Dissipative flooring. Multicoloured tiles with a hammered surface.  
 Revêtement de sol dissipateur. Dalles multicolores avec surface martelée.  
 Ableitfähige Fußbodenbeläge. Mehrfarbige Fliesen mit Hammerschlagoberfläche.  
 Pavimento dissipativo. Baldosas multicolores con superficie martilleada.

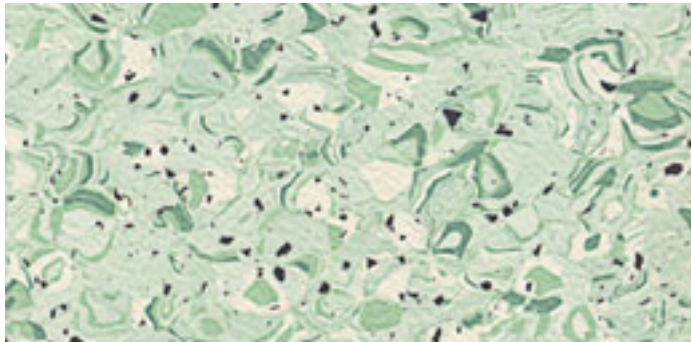
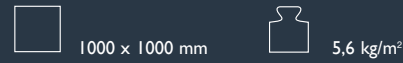
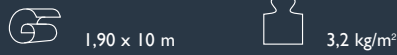

GD 217C

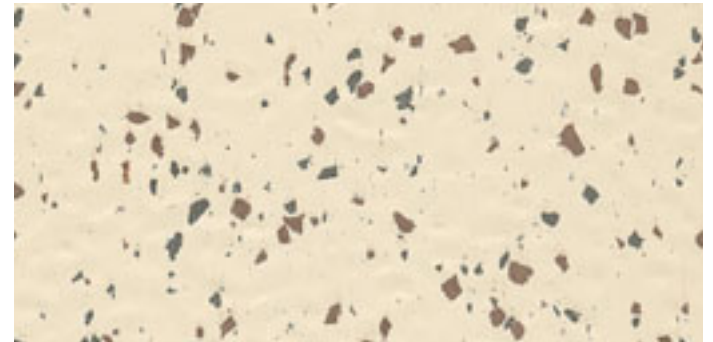

Z 630

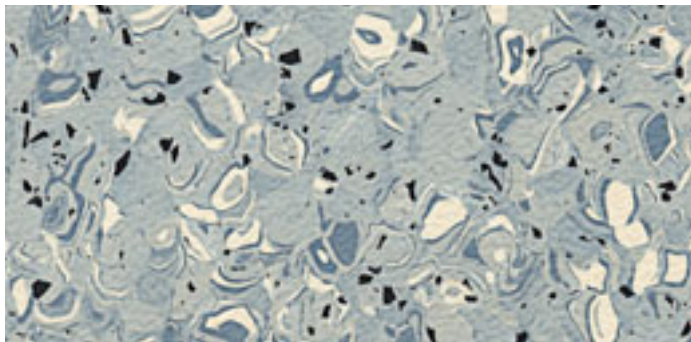

GD 207C

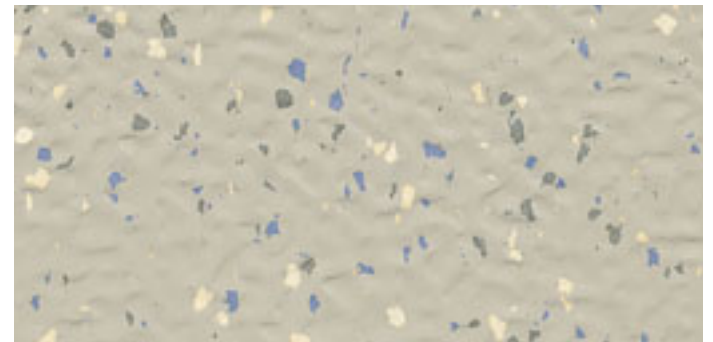

Z 642

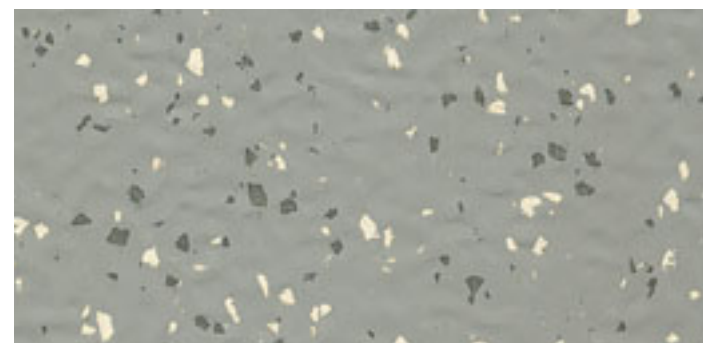

Z 626

Piastrelle monocolori con rilievi a bolli.  
 Solid colour round studded tiles.  
 Dalles en teinte unie avec relief à pastille ronde.  
 Einfarbige Fliesen mit Hohlkehrl-Rundnoppen.  
 Baldosas monocolor con relieve de círculos con perfil redondeado.

I numeri in grassetto indicano la categoria di prezzo.  
 The numbers in bold type indicate the price category.  
 Les numéros en gras indiquent la catégorie de prix.  
 Die fett gedruckten Zahlen geben die Preiskategorien an.  
 Los números en negrita indican la categoría de precio.

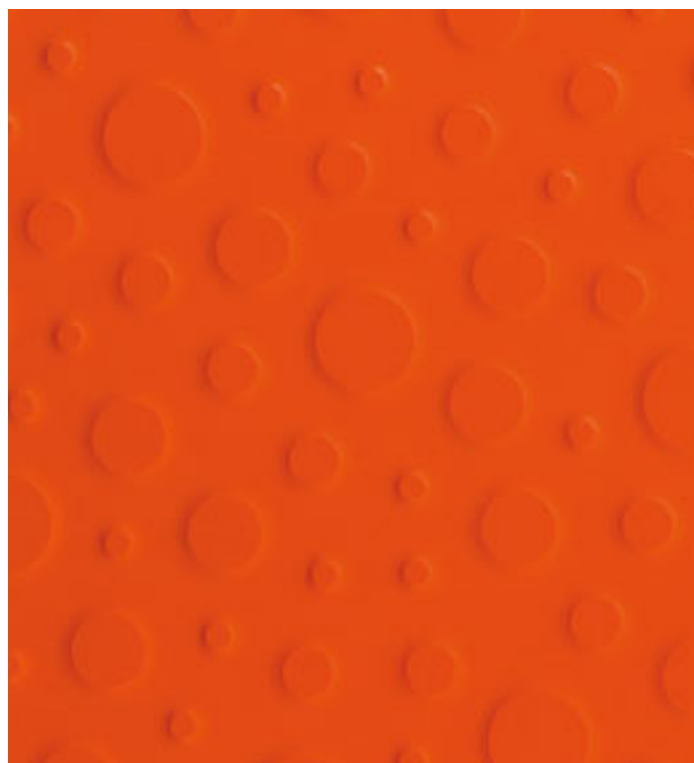
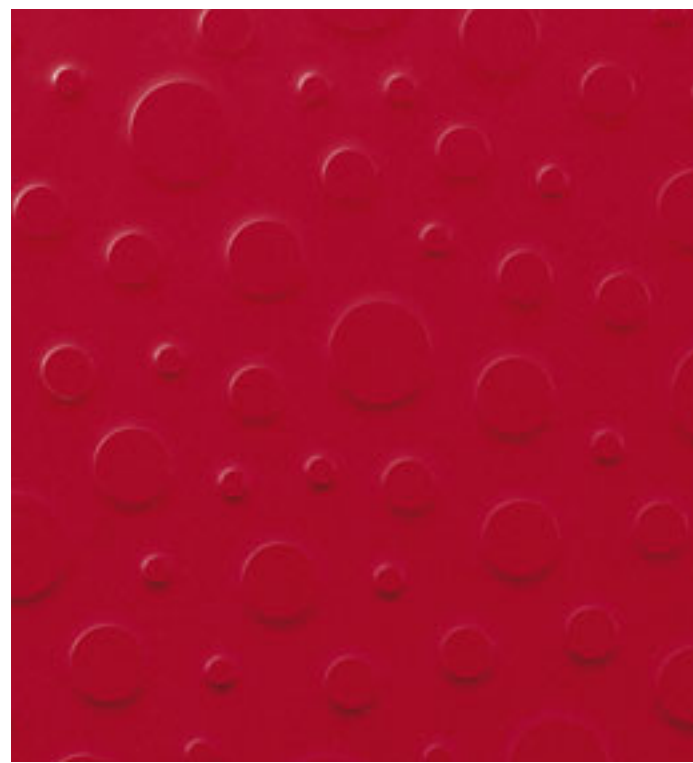
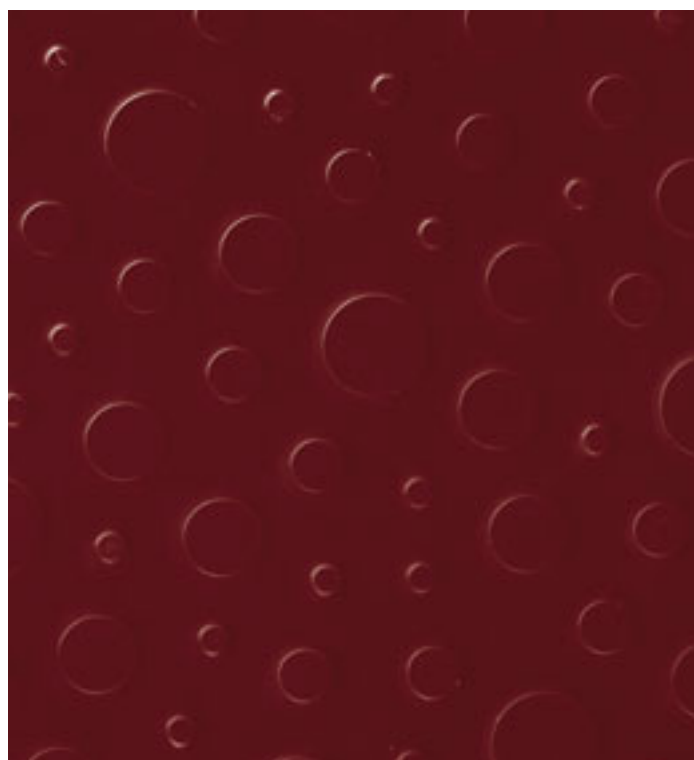
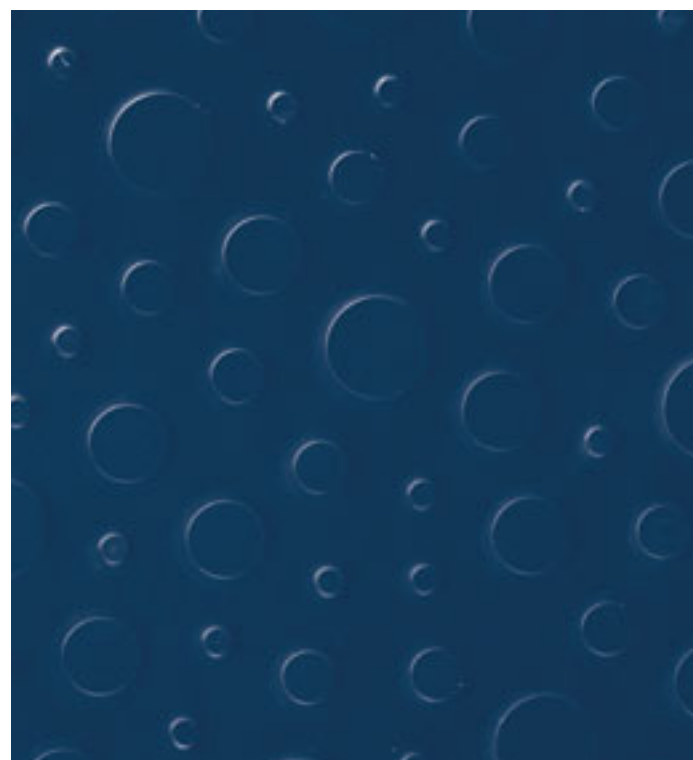
Y 510 **3**R 922 **3**R 960 **3**B 207 **2**

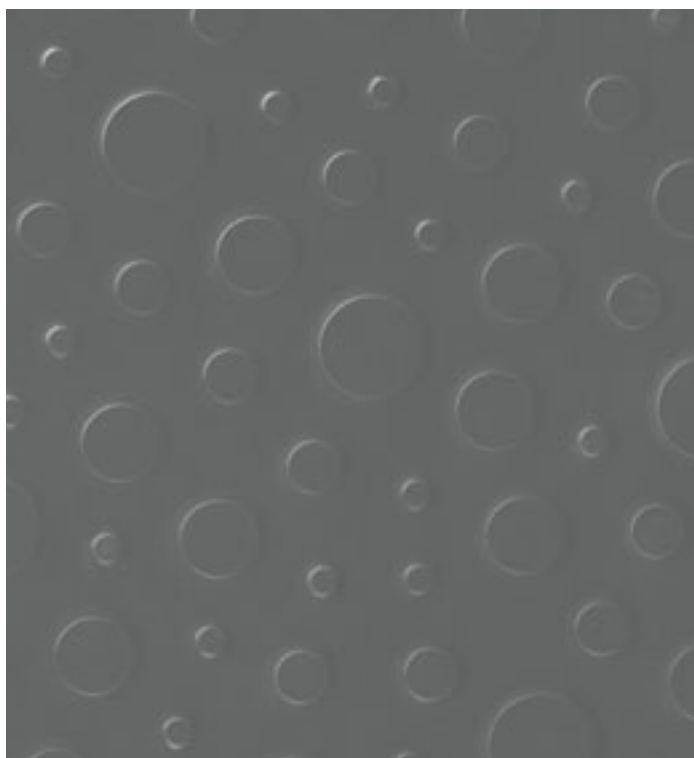

G 804 2

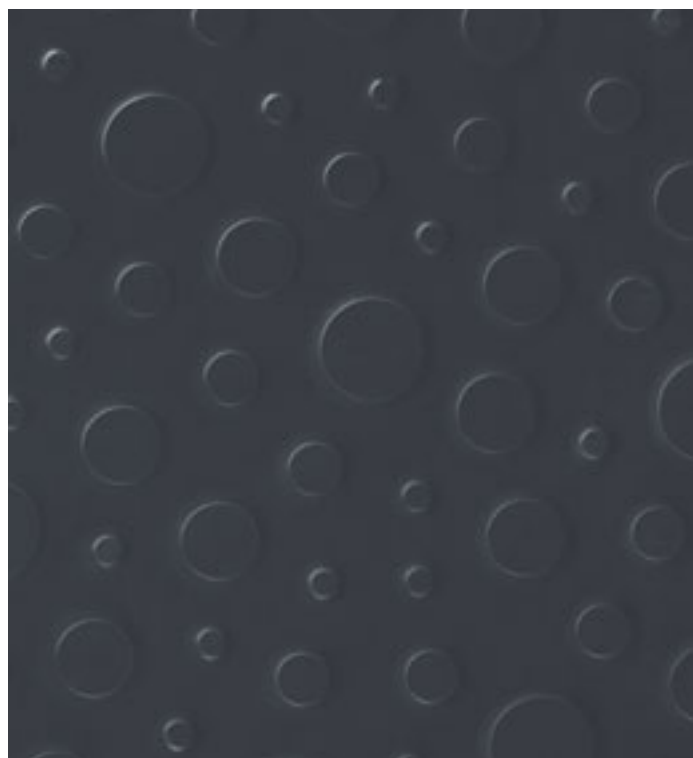

G 805 2

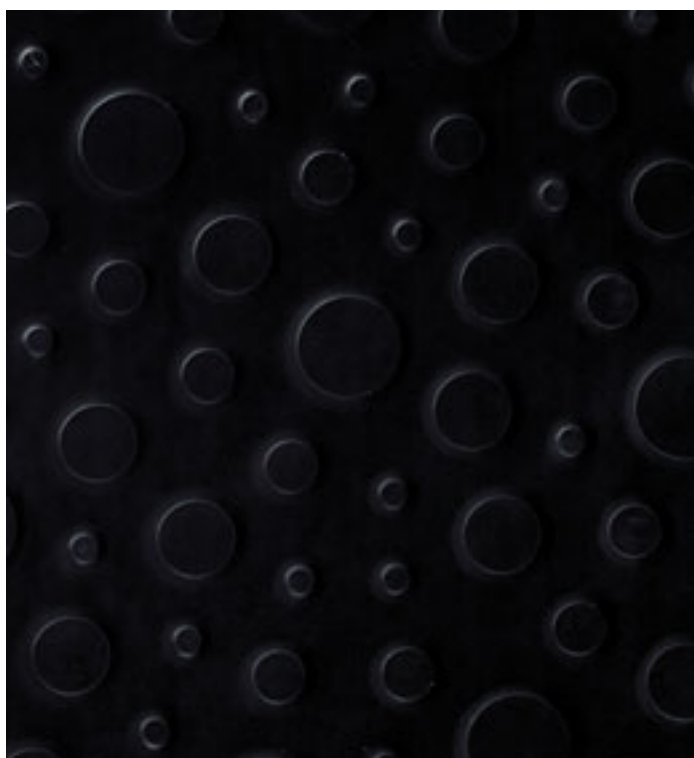

N 004 1

Piastrelle monocolor con rilievi a bolli.  
 Solid colour round studded tiles.  
 Dalles en teinte unie avec relief à pastille ronde.  
 Einfarbige Fliesen mit Hohlkehrl-Rundnoppen.  
 Baldosas monocolor con relieve de circulos con perfil redondeado.

Standard: N 004, G 805, G 804, G 820, B 207, V 709, G 847, Y 507, Y 510, R 922.

28 mm  
 = 0,5 mm — 2,7 mm

500 × 500 mm

3,8 kg/m<sup>2</sup>



28 mm  
 = 0,5 mm — 4,0 mm

1000 × 1000 mm

5,2 kg/m<sup>2</sup>



Y 507 Helios 3 •



G 837 Python 2



Y 510 Orange 3 •



M 120 Desert 2



R 922 Love 3 •



V 700 Sage 2



R 904 Ocra 2



V 733 Nile 2



M 104 Choco 2



V 709 Mint 3 •

I numeri in grassetto indicano la categoria di prezzo.  
The numbers in bold type indicate the price category.  
Les numéros en gras indiquent la catégorie de prix.  
Die fett gedruckten Zahlen geben die Preiskategorien an.  
Los números en negrita indican la categoría de precio.

G 804 Metal **2** •G 820 Pearl **2** •B 265 Steel **2**G 811 Silver **2**B 264 Cloud **2**G 805 Eiffel **2** •B 207 Jeans **3** •G 847 Slate **2** •B 206 Capri **3**N 004 Carbon **1** •

Doghe con superficie a scanalature irregolari.  
Planks with irregular fluted surface.  
Lames avec surface à cannelures irrégulières.  
Dielen mit ungleichmäßiger Rillenoberfläche.  
Lamas con superficie con acanalados irregulares.

 = 0,1-0,3 mm — 3,0 mm

 1000 x 200 mm

 4,8 kg/m<sup>2</sup>

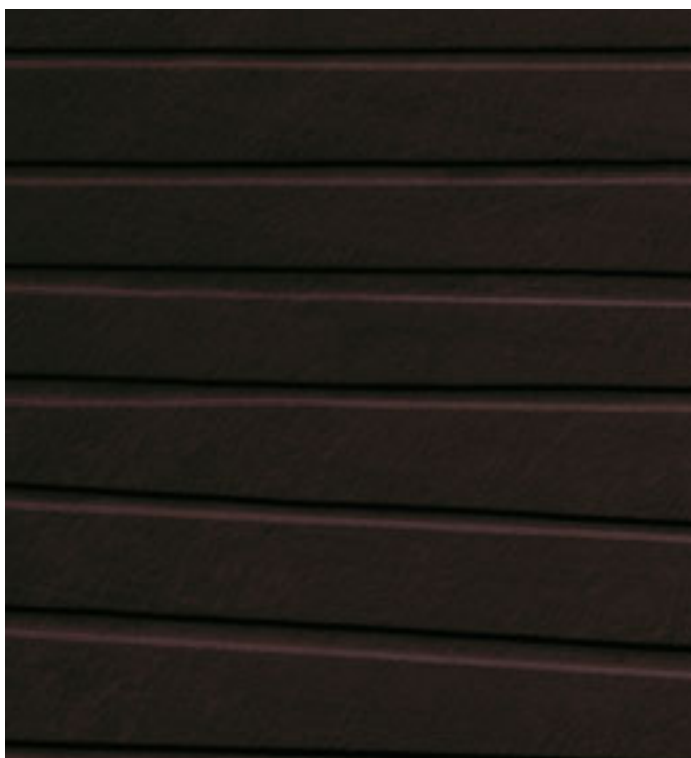

M 163

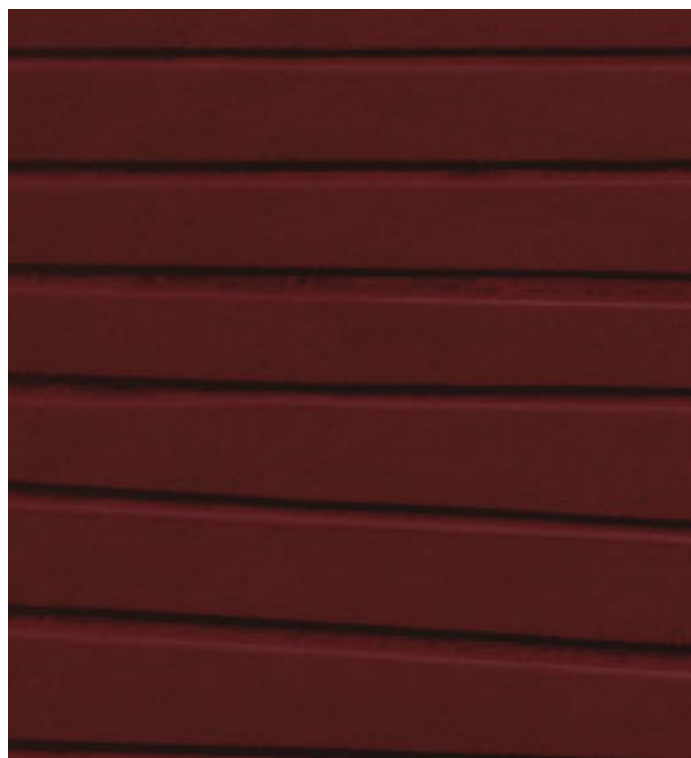

R 960

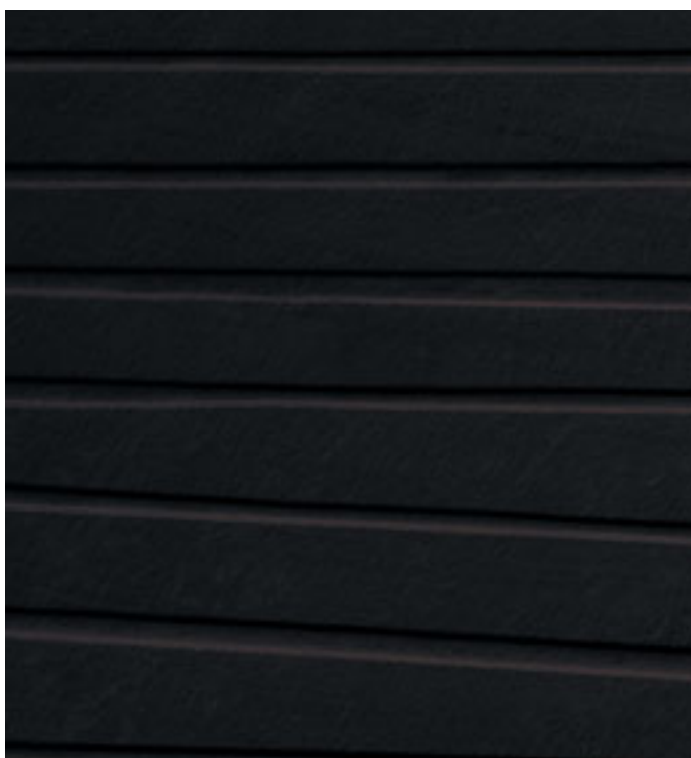

M 164

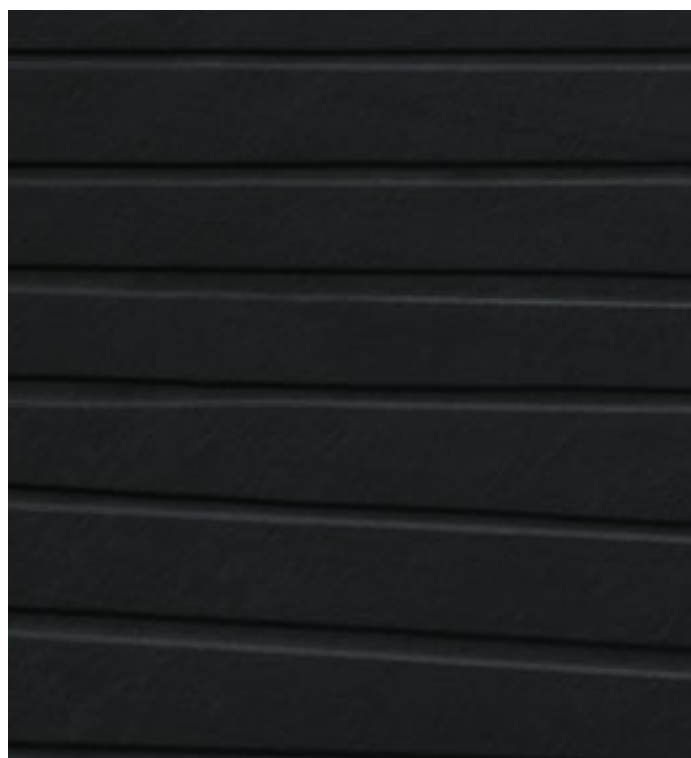

N 004

Piastrelle in tinta unita con superficie a rilievo ardesia.  
Solid colour slate pattern tiles.  
Dalles avec surface en relief ardoise.  
Einfarbige Fliesen mit Schieferstruktur.  
Baldosas monocolor con superficie de relieve pizarra.

3,5 mm



1000 x 1000 mm



5,2 kg/m<sup>2</sup>



G 847



N 004

Piastrelle multicolori con superficie martellata.  
 Multicoloured tiles with a hammered surface.  
 Dalles multicolores avec surface martelée.  
 Mehrfarbige Fliesen mit Hammerschlagoberfläche.  
 Baldosas multicolores con superficie martilleada.



3,5 mm

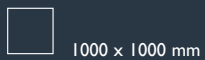

1000 x 1000 mm

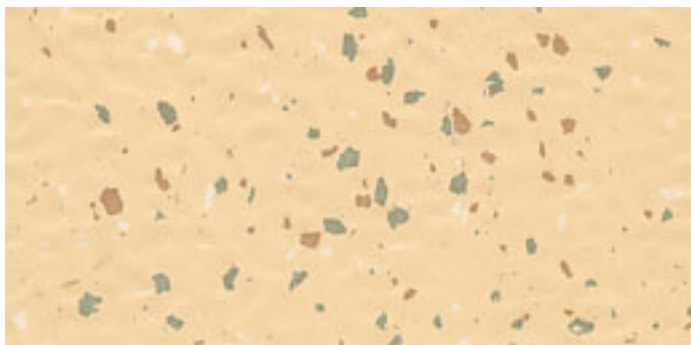
5,6 kg/m<sup>2</sup>
 Classificazione / Classification UPEC U<sub>4</sub> P<sub>3</sub> E<sub>2</sub> C<sub>1</sub>

Z 629

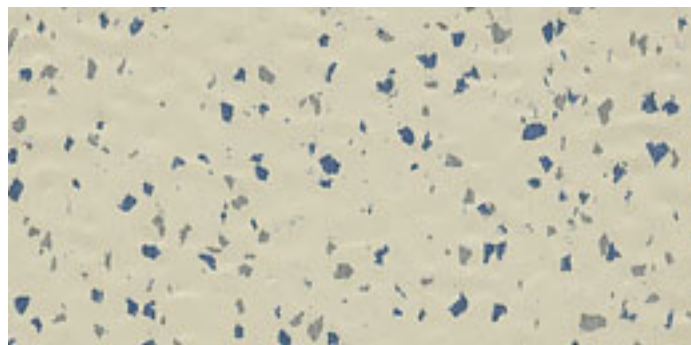

Z 640

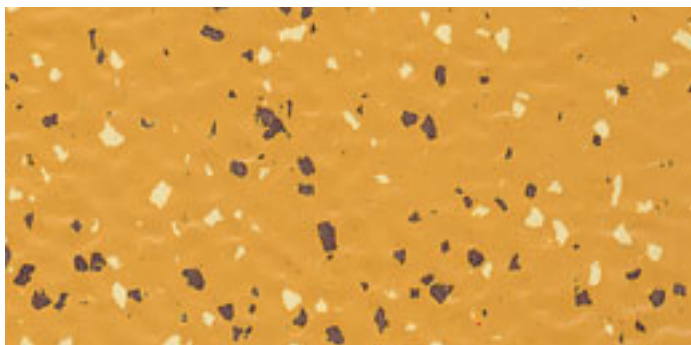

Z 637

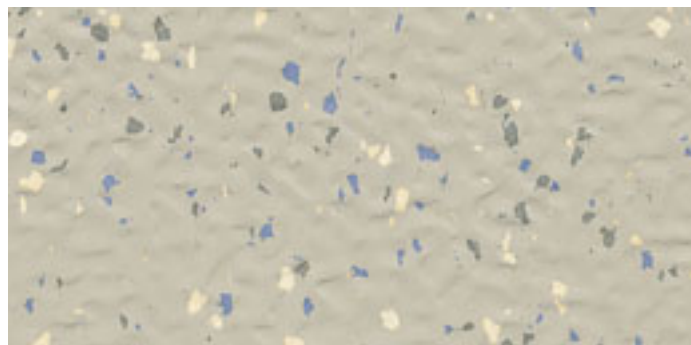

Z 642

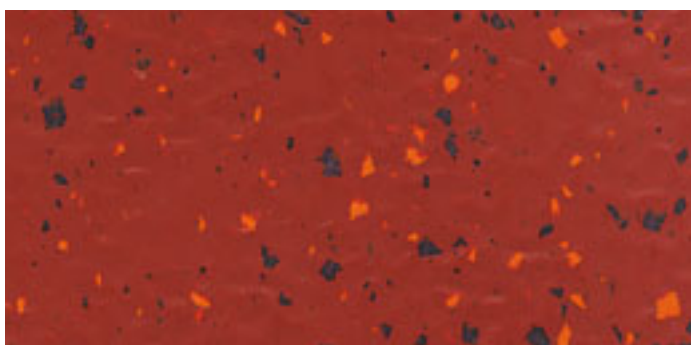

Z 631

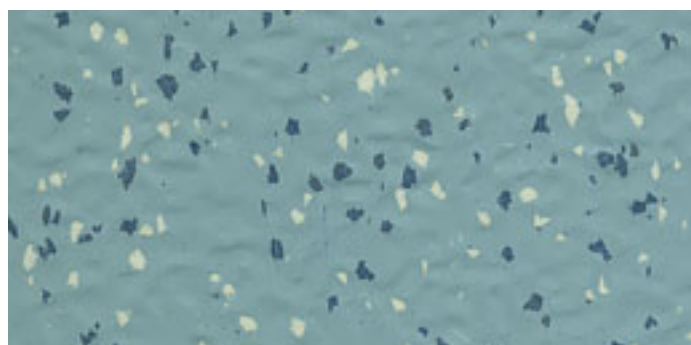

Z 635

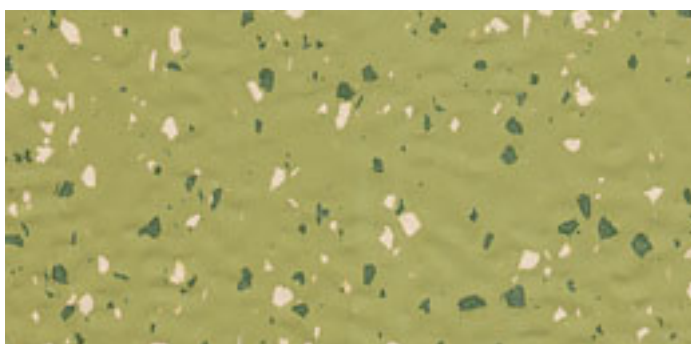

Z 634

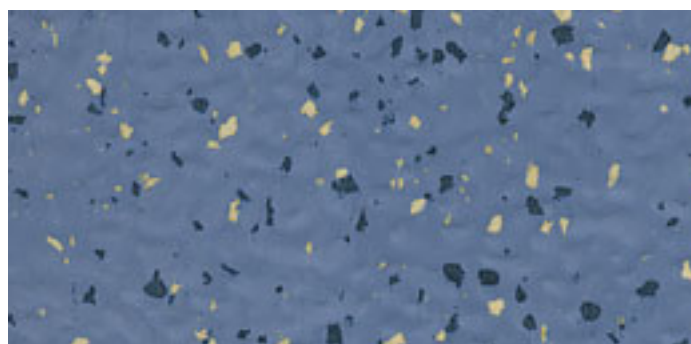

Z 632



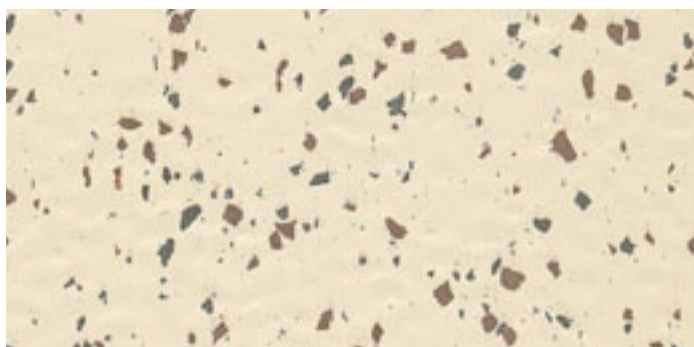

Z 630

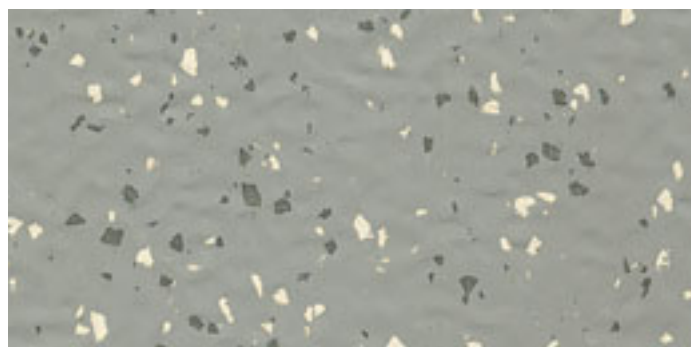

Z 626

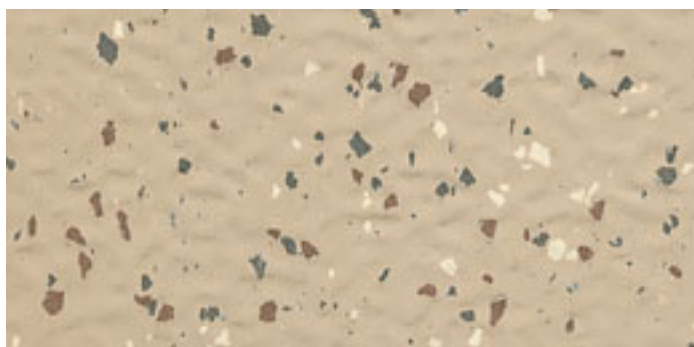

Z 628

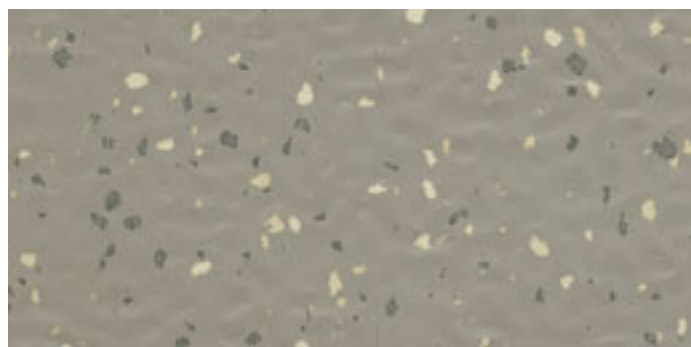

Z 639

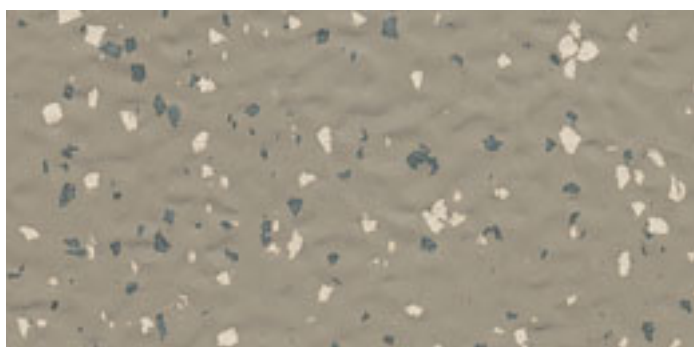

Z 636

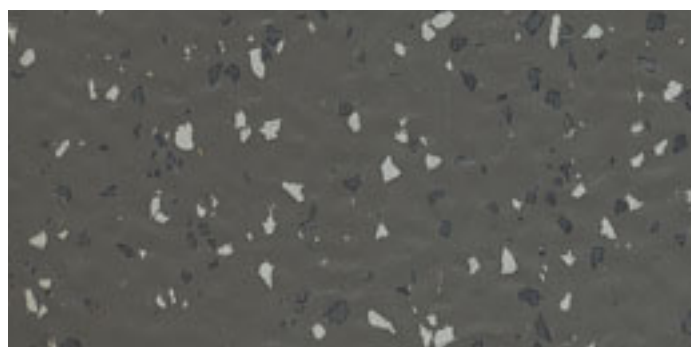

Z 638

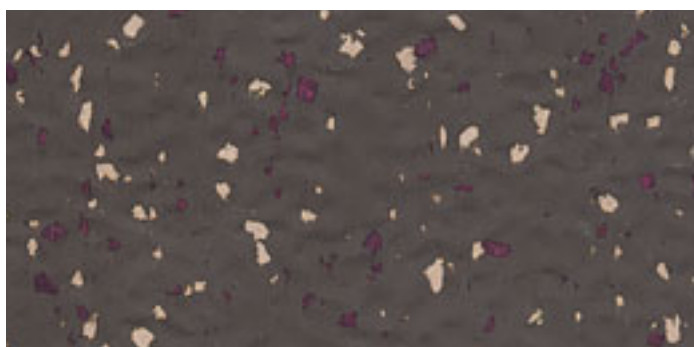

Z 633

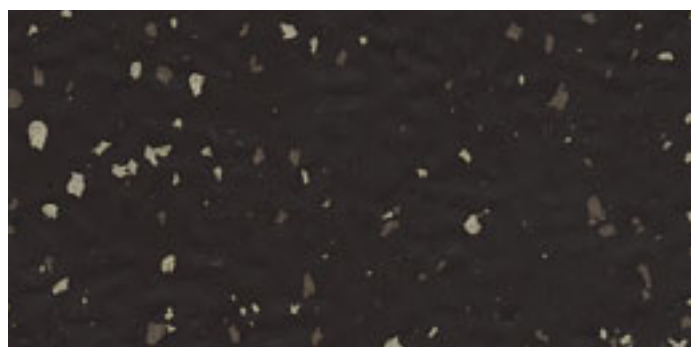

Z 641

Pavimento in rotoli con superficie a rilievo con bollo basso.  
 Low stud flooring in rolls for heavy traffic.  
 Revêtement de sol en rouleaux avec surface en relief à pastille basse.  
 Rollenbelag mit niedrigen Rundnoppen.  
 Pavimento en rollos con superficie de relieve círculos bajos.



Pavimento in rotoli con superficie a rilievo con bollo alto.  
 High stud flooring in rolls for heavy traffic.  
 Revêtement de sol en rouleaux avec surface en relief à pastille haute.  
 Rollenbelag mit hohen Rundnoppen.  
 Pavimento en rollos con superficie de relieve círculos alto.

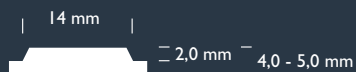

G 804



G 805



G 805



B 206



B 206



N 004



N 004

Pavimento in rotoli con superficie a grande rigatura.  
 Flooring in rolls with large ribbed profile.  
 Revêtement de sol en rouleaux avec surface à profil grande cannelure.  
 Rollenbelag mit grossen Rillen.  
 Pavimento en rollos con superficie de grandes estrias.



mod. 279

 1,20 x 10 m



Piastrelle monocolor con rilievi a bolli. Per posa con attacco cemento.  
 Solid colour round studded tiles. Cement bonding laying.  
 Dalles en teinte unie avec relief à pastille ronde. Pour pose au béton.  
 Einfarbige Fliesen mit Hohlkehrl-Rundnoppen. Für Zementverlegung.  
 Baldosas monocolor con relieve de círculos. Para colocación con cemento.



 1000 x 1000 mm  
 cement bonding: 1000 x 1000 mm

 5,0 kg/m<sup>2</sup>  
 cement bonding: 9,5 kg/m<sup>2</sup>



G 805



N 004



N 004

Rivestimenti gradini a spigolo vivo. I numeri in grassetto indicano la categoria di prezzo.

Square nosed step covering. The numbers in bold type indicate the price category.

Marches integrales pour escalier à nez vif. Les numéros en gras indiquent la catégorie de prix.

Beläge für stufen mit rechtwinkligen kanten. Die fett gedruckten Zahlen geben die Preiskategorien an.

Revestimento de peldaños con bordes vivos. Los números en negrita indican la categoría de precio.

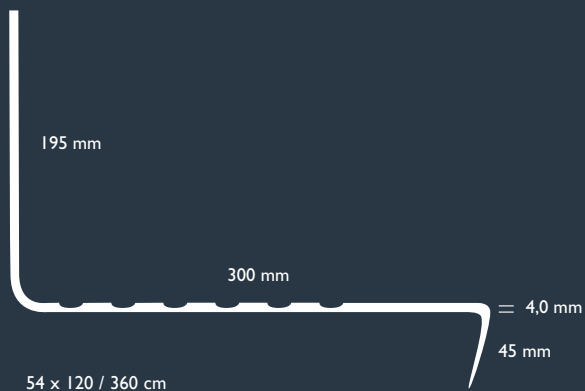

**BS R 922 3**



**BS G 820 2**



**BS G 847 2**



**BS G 804 2**



**BS N 004 1**



**BS G 805 2**

Rivestimenti gradini a spigolo arrotondato. I numeri in grassetto indicano la categoria di prezzo.  
 Round nosed step covering. The numbers in bold type indicate the price category.  
 Marches integrales pour escaliers à nez arrondi. Les numéros en gras indiquent la catégorie de prix.  
 Beläge für stufen mit gerundeten kanten. Die fett gedruckten Zahlen geben die Preiskategorien an.  
 Revestimiento de peldaños con bordes redondeados. Los números en negrita indican la categoría de precio.



**BS R 922 3**



**BS G 820 2**



**BS G 847 2**



**BS G 804 2**



**BS N 004 1**



**BS G 805 2**

Profili in gomma per rivestimento gradini a spigolo vivo.  
 Rubber profiles for covering sharp-edged steps.  
 Profils en caoutchouc pour le revêtement des marches à arête vive.  
 Gummiprofile zur Verkleidung von scharfkantigen Stufen.  
 Perfiles en goma para revestimiento peldaños de arista viva.

Profilo per sguscia.  
 Cove former.  
 Profils pour remontée.  
 Hohlkehlnprofil.  
 Perfil de salida.

SN 001

SN 002



Y 507



N 004



G 804



G 805

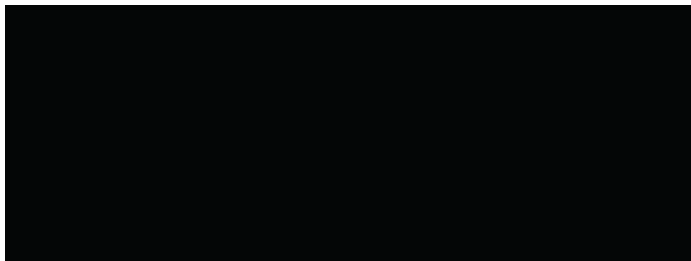

N 004

Profili per scale.  
Stair profiles.  
Plinthes pour escalier.  
Treppenwinkel.  
Perfiles para escaleras.

SA 400/I - SA 500/I

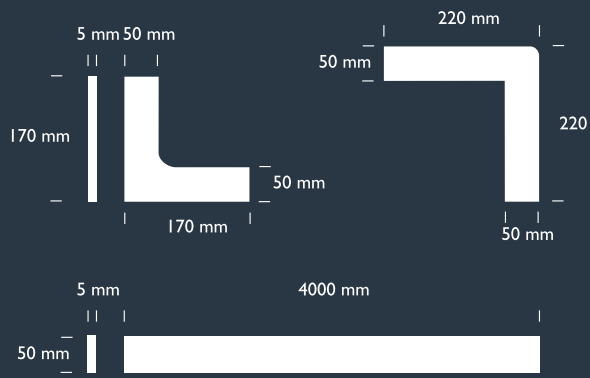

SA 200/E - SA 300/E

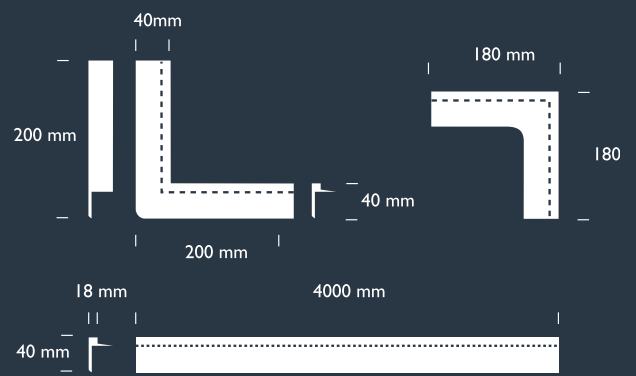

G 804



G 805



N 004



V 709



U 27



R 904



G 820



B 207



G 804



G 805

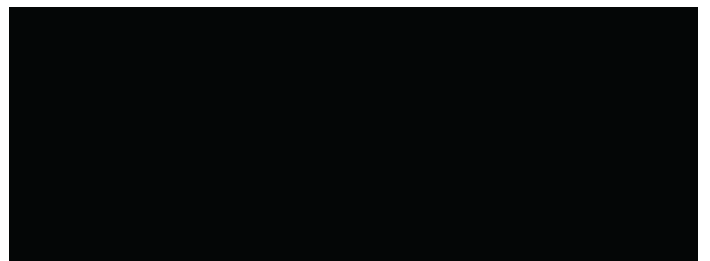

N 004



Cordolo per sigillatura a caldo per pavimenti Plansystem.  
 Hot sealing for Plansystem floorings.  
 Scellement à chaud pour les sols Plansystem.  
 Thermoschnur zum Verfugen der Plansystem Bodenbeläge.  
 Córdón para sellado por calor de los pavimentos Plansystem.

Il codice a lato del campione indica i prodotti abbinabili.  
 The code number on the sample indicates the products that can be matched.  
 Le code à côté de l'échantillon indique les produits que l'on peut assortir.  
 Der Code am Rand des Musters weist auf kombinierbare Produkte hin.  
 El código al lado de la muestra indica los productos combinables.

● Ø 3,8 mm

 100 m













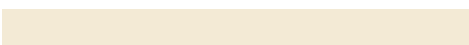















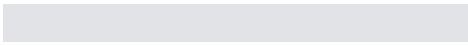



	K73		U26
C11		C45	
	G363		G371
C61		C53	
	G315 - U27 - M33 - K27		U16
C81		C107	
	G365		U18
C40		C125	
	U11		G342
C100		C51	
	K71		M19
C138		C19	
	U56		K62
C141		C108	
	U13		U39 - K39
C113		C106	
	U14		K01
C124		C111	
	K63		G370
C109		C42	
	U54 - K54		G368
C102		C112	
	G378		U36
C44		C104	
	K72		G305 - U20 - M20
C116		C30	
	K38		G306 - U17 - M02 - K17
C105		C16	
	M15		U55
C62		C103	
	G336		G308 - U21 - K21
C36		C21	
	G372		U00 - M00 - K00
C43		C00	

Diagramma riassuntivo del sistema

Key to symbols

Légende symboles

Erklärung der Symbole

Leyenda símbolos

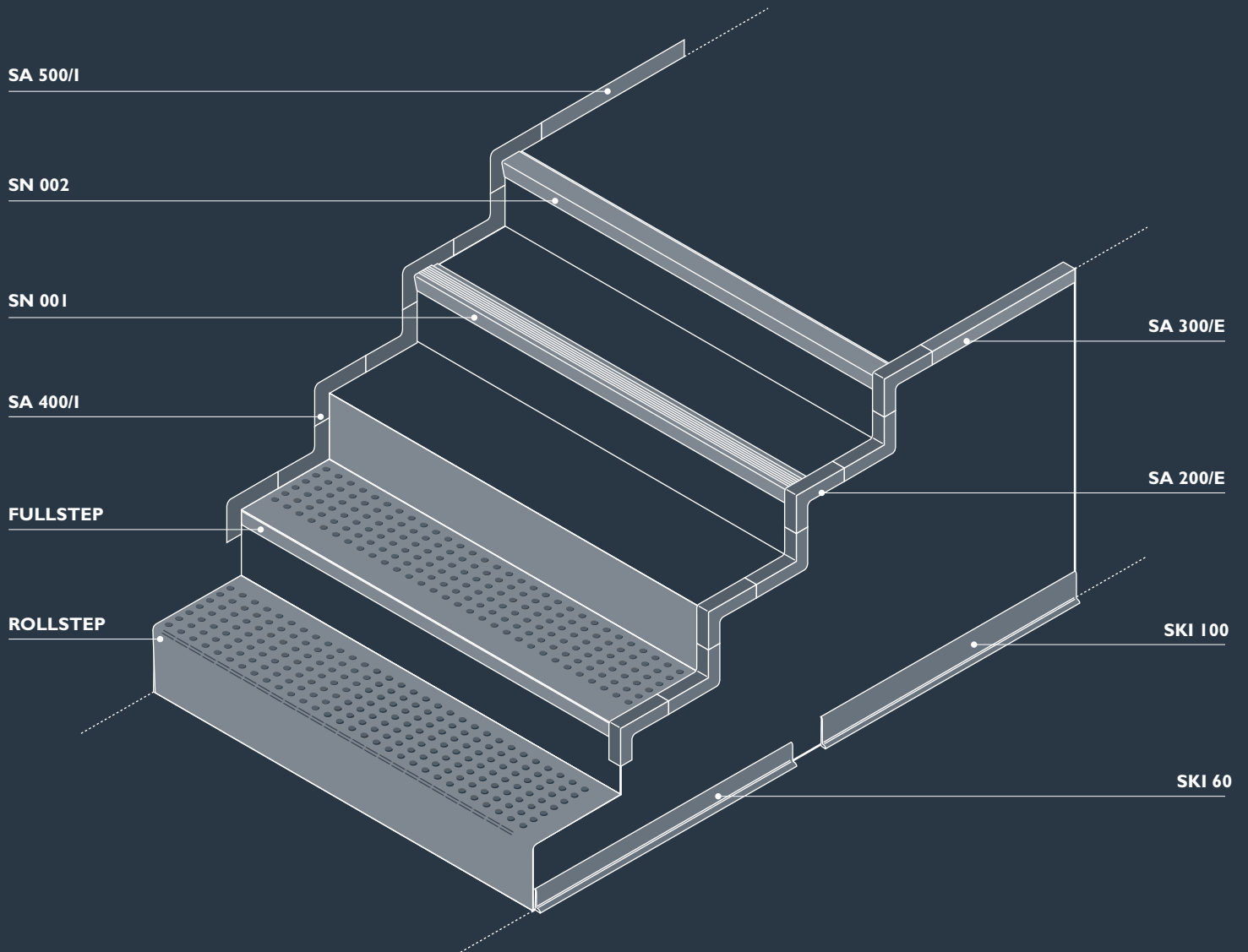

**Rivestimenti gradini**  
**Step covering**  
**Revêtements pour marches**  
**Formtreppen**  
**Revestimientos de peldaños**

**FULLSTEP**

Rivestimenti gradini a spigolo vivo. Rivestimento gradino costituito da pedata con rilievo a bolli bassi, paraspigolo e alzata liscia in un sol pezzo.

Square nosed step covering. One-piece step covering with studded tread, smooth nosing and riser.

Marches integrales pour escalier à nez vif. Marche intégrale constituée d'une marche avec relief à pastille basse, nez de marche et contremarche lisse dans une seule pièce.

Beläge für stufen mit rechtwinkligen kanten. Einteiliges Formtreppenteil, mit genopptem Trittstufenteil, Treppenkante und glatter Setzstufe.

Revestimiento de peldaños con bordes vivos. Revestimiento de peldaño formado por peldaño en relieve a círculos bajos, moldura y contropeldaño en una sola pieza.

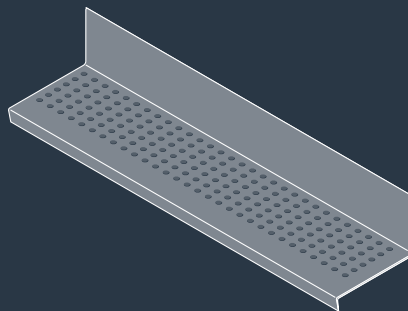

**ROLLSTEP**

Rivestimenti gradini a spigolo arrotondato. Rivestimento gradino costituito da pedata con rilievo a bolli bassi, paraspigolo con rigature trasversali e alzata liscia.

Round nosed step covering. Step covering in rolls (12 m) with a low studded tread ribbed nosing and smooth riser.

Marches integrales pour escaliers à nez arrondi. Marche intégrale en rouleaux constituée d'une marche avec relief à pastille basse, de nez de marche cannelé et de contremarche lisse.

Beläge für stufen mit gerundeten kanten. Rollen- Formtreppenstufen: Trittstufe mit Rundnoppen, gerippten Treppenkanten mit geringem Verschnitt und glatter Setzstufe.

Revestimiento de peldaños con bordes redondeados. Revestimiento de peldaños formado por el peldaño con relieve a círculos bajos, moldura con estrias transversales y contrapeldaño liso.

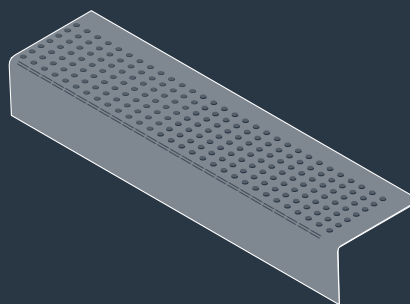

**Accessori**  
**Accessories**  
**Accessoires**  
**Zubehör**  
**Accesorios**

**SA 500/I**

Battiscopa interno per pianerottolo  
 Internal skirting for landing  
 Plinthe intérieure pour palier  
 Podestleiste wandseitig  
 Zócalo interior para rellanos

**SN 002**

Paragradino liscio per gradini a spigolo vivo  
 Smooth stair nosing for square nosed steps  
 Nez de marches lisses pour marches à nez vif  
 Treppenkante glatt (für scharfkantige Stufen)  
 Moldura lisa para peldaños con bordes vivos

**SN 001**

Paragradino rigato per gradini a spigolo vivo  
 Ribbed stair nosing for square nosed steps  
 Nez de marches striés pour marches à nez vif  
 Treppenkante gerillt (für scharfkantige Stufen)  
 Moldura con estrias para peldaños con bordes vivos

**SA 400/I**

Angolari interni per gradini a spigolo vivo  
 Internal stair angles for square nosed steps  
 Angles intérieurs d'escaliers à nez vif pour paliers  
 Treppenwinkel wandseitig (für scharfkantige Stufen)  
 Angulares interiores para peldaños con bordes vivos

**SA 300/E**

Battiscopa esterno per pianerottolo  
 External skirting for landing  
 Plinthe extérieure pour palier  
 Podestleiste aussen  
 Zócalo exterior para rellanos

**SA 200/E**

Angolari esterni per gradini a spigolo vivo  
 External stair angles for square nosed steps  
 Angles extérieurs d'escalier à nez vif pour palier  
 Treppenwinkel aussen (für scharfkantige Stufen)  
 Angulares exteriores para peldaños con bordes vivos

**SKI 100**

Battiscopa altezza ca. 100 mm  
 Skirting ca. 100 mm in height  
 Plinthe hauteur ca. 100 mm  
 Sockelleiste ca. 100 mm hoch  
 Zócalo de ca. 100 mm de altura

**SKI 60**

Battiscopa altezza ca. 60 mm  
 Skirting ca. 60 mm in height  
 Plinthe hauteur ca. 60 mm  
 Sockelleiste ca. 60 mm hoch  
 Zócalo de ca. 60 mm de altura

caratteristiche characteristics caractéristiques Eigenschaften características	norma standard norme Norm norma	u. di misura unité unite Masseinheit unidad	requisiti requirements exigences Anforderung valores	KAYAR ND / UNI ND / NAT	GRANITO	GRANITO ELASTIC	GRANITO ANT 48	GEODE COND	GRAIN
durezza hardness dureté Härte dureza	ISO 7619	shore A	≥ 75	85 ± 5	88 ± 5	85 ± 5	85 ± 5	90 ± 5	90 ± 5
impronta residua residual indentation poinçonnement rémanent Resteindruck punzonamiento residual	EN 433	mm	≤ 0,15 ≤ 0,20 ≤ 0,25	0,08 - -	0,05 - -	- - 0,20	0,08 - -	0,07 - -	- - 0,08
resistenza all'abrasione abrasion resistance résistance à l'abrasion Abriebfestigkeit resistencia a la abrasión	ISO 4649 (Met. A - 5N)	mm <sup>3</sup>	≤ 250	190 Kayar 165 Nd / Uni 170 Nd / Nat	150	170	160	160	160
stabilità dimensionale dimensional stability stabilité dimensionnelle Maßbeständigkeit estabilidad dimensional	EN 434	%	± 0,40 max	± 0,30					
flessibilità flexibility flexibilité Biegsamkeit flexibilidad	EN 435 Met. A (Ø 20 mm)		nessuna fessurazione no fissuring pas de formation de fissurations keine Ribildung ninguna fisura	conforme comply geeignet					
solidità del colore alla luce artificiale colour fastness to artificial light essais de tenue des couleurs à la lumière artificielle Farbbeständigkeit gegenüber künstlichem Licht solidez del color a la luz artificial	ISO 105-B02 Met. 3	grado degree degré Stufe	≥ 6 scala dei blu; ≥ 3 scala dei grigi ≥ 6 blue scale; ≥ 3 grey scale ≥ 6 échelle de bleu; ≥ 3 échelle de gris ≥ 6 des Blaumaßstabs; ≥ 3 des Graumaßstabs ≥ 6 escala de azules; ≥ 3 escala de grises	conforme comply geeignet					
effetto bruciatura sigaretta cigarette burn résistance aux cigarettes incandescentes Einwirkung glimmender Tabakwaren efecto quemadura cigarrillos	EN 1399	rating Stufe	met. A ≥ 4 met. B ≥ 3	conforme comply geeignet					
reazione al fuoco fire behaviour comportement au feu Brandverhalten reacción al fuego	EN 13501-1	classe class classe Klasse		Bfi - s l Kayar Nd / Uni Bfi - s l <sup>(1)</sup> Nd / Nat	Bfi - s l	Bfi - s l <sup>(1)</sup>	Bfi - s l	Cfi - s l	Bfi - s l
resistenza allo scivolamento slip resistance résistance au glissement Rutschhemmung resistencia al deslizamiento	EN 13893	classe class classe Klasse	≥ 0,30 (DS)	≥ 0,30					
resistenza alle macchie resistance to stains résistance aux taches Chemikalienbeständigkeit resistencia a las manchas	EN 423			resistente <sup>(2)</sup> resistant <sup>(2)</sup> résistant <sup>(2)</sup> beständig <sup>(2)</sup>					
carica elettrostatica da calpestio electrostatic charge charge électrostatique à la marche Elektrostatishes Verhalten beim Begehen carga electrostática a la pisada	EN 1815	kV		≤ 2					
riduzione del rumore da calpestio reduction of sound due to treading insolation acoustique à la marche Trittschallverbesserungsmaß reducción del ruido a la pisada	ISO 10140-3	dB (approx.)		10	6	20	6	6	10
effetto sedia a rotelle castor chairs l'action d'une chaise à roulettes Stuhlrollenversuch efecto de las sillas de ruedas	EN 425			adatto con ruote tipo W suitable for W castors convient aux chaises à roulettes type W geeignet für Rollen Typ W adecuado con ruedas tipo W					
comportamento elettrico electrical behaviour comportement électrique Erdbleitwiderstand comportamiento eléctrico	EN 1081 Met. A	ohm	Ant 48: Rv ≤ 10 <sup>9</sup> static dissipative Cond: Rv ≤ 10 <sup>6</sup> conductive				≤ 10 <sup>9</sup>	≤ 10 <sup>6</sup>	

<sup>(1)</sup> incollato / bonded / collé / verklebt / pegado

<sup>(2)</sup> in base a concentrazione e tempo di contatto, per agenti specifici inoltrare richiesta / depending on concentration and time of contact, for specific agents please ask / dépend du produit de sa concentration et de sa durée de contact avec le revêtement. Pour plus d'informations contactez nos services techniques / abhängig von Konzentration und Einwirkzeit, bei speziellen Chemikalien ist Rücksprache erforderlich / en función a la concentración y el tiempo de contacto, consultar para productos específicos

caratteristiche characteristics caractéristiques Eigenschaften características	norma standard norme Norm norma	u. di misura unit unité Masseinheit unidad	requisiti requirements exigences Anforderung valores	UNI LL KAYAR LL	BS CLASSIC BS STRONG	ZERO.4	EBONY ARDESIA	ZEUS	ZEUS ANT 48
durezza hardness dureté Härte dureza	ISO 7619	shore A	≥ 70 ≥ 75	85 ± 5	90 ± 5	90 ± 5	85 ± 5	85 ± 5	85 ± 5
impronta residua residual indentation poïnçonnement rémanent Resteindruck punzonamiento residual	EN 433	mm	≤ 0,20 ≤ 0,25	≤ 0,20	0,08 Classic 0,12 Strong	- 0,10	0,08 Ebony 0,10 Ardesia	- 0,10	- 0,15
resistenza all'abrasione abrasion resistance résistance à l'abrasion Abriebfestigkeit resistencia a la abrasión	ISO 4649 (Met. A - 5N)	mm <sup>3</sup>	≤ 250	190 Kayar 150 Uni	140	140	150	140	160
stabilità dimensionale dimensional stability stabilité dimensionnelle Maßbeständigkeit estabilidad dimensional	EN 434	%	± 0,40 max	± 0,30					
flessibilità flexibility flexibilité Biegsamkeit flexibilidad	EN 435 Met. A (Ø 20 mm)		nessuna fessurazione no fissuring pas de formation de fissurations keine Rißbildung ninguna fisura	conforme comply geegnet					
solidità del colore alla luce artificiale colour fastness to artificial light essais de tenue des couleurs à la lumière artificielle Farbbeständigkeit gegenüber künstlichem Licht solidez del color a la luz artificial	ISO 105-B02 Met. 3	grado degree degré Stufe	≥ 6 scala dei blu; ≥ 3 scala dei grigi ≥ 6 blue scale; ≥ 3 grey scale ≥ 6 échelle de bleu; ≥ 3 échelle de gris ≥ 6 des Blaumaßstabs; ≥ 3 des Graumaßstabs ≥ 6 escala de azules; ≥ 3 escala de grises	conforme comply geegnet					
effetto bruciatura sigaretta cigarette burn résistance aux cigarettes incandescentes Einwirkung glimmender Tabakwaren efecto quemadura cigarrillos	EN 1399	rating Stufe	met. A ≥ 4 met. B ≥ 3	conforme comply geegnet					
reazione al fuoco fire behaviour comportement au feu Brandverhalten reacción al fuego	EN 13501-I	classe class classe Klasse		Bii - s I	Bii - s I	Bii - s I	Bii - s I	Bii - s I	Bii - s I
resistenza allo scivolamento slip resistance résistance au glissement Rutschhemmung resistencia al deslizamiento	EN 13893	classe class classe Klasse	≥ 0,30 (DS)	≥ 0,30					
resistenza alle macchie resistance to stains résistance aux taches Chemikalienbeständigkeit resistencia a las manchas	EN 423			resistente <sup>(1)</sup> resistant <sup>(1)</sup> résistant <sup>(1)</sup> beständig <sup>(1)</sup>					
carica elettrostatica da calpestio electrostatic charge charge électrostatique à la marche Elektrostatisches Verhalten beim Begehen carga electrostática a la pisada	EN 1815	kV		≤ 2					
riduzione del rumore da calpestio reduction of sound due to treading insolation acoustique à la marche Trittschallverbesserungsmaß reducción del ruido a la pisada	ISO 10140-3	dB (approx.)		16	8 Classic 10 Strong	8	8 Ebony 12 Ardesia	12	12
effetto sedia a rotelle castor chairs l'action d'une chaise à roulettes Stuhlrollenversuch efecto de las sillas de ruedas	EN 425			adatto con ruote tipo W suitable for W castors convient aux chaises à roulettes type W geeignet für Rollen Typ W adecuado con ruedas tipo W					
comportamento elettrico electrical behaviour comportement électrique Erdableitwiderstand comportamiento eléctrico	EN 1081 Met. A	ohm	Ant 48: Rv ≤ 10 <sup>9</sup> static dissipative	≤ 10 <sup>9</sup>					

<sup>(1)</sup> in base a concentrazione e tempo di contatto, per agenti specifici inoltrare richiesta / depending on concentration and time of contact, for specific agents please ask / dépend du produit de sa concentration et de sa durée de contact avec le revêtement. Pour plus d'informations contactez nos services techniques / abhängig von Konzentration und Einwirkzeit, bei speziellen Chemikalien ist Rücksprache erforderlich / en función a la concentración y el tiempo de contacto, consultar para productos específicos

I dati tecnici riportati in questo catalogo possono essere soggetti a modifiche senza preavviso.

The technical details shown in this catalogue are subject to change without notice.

Les données techniques figurant dans ce catalogue peuvent être sujettes à modifications sans avis préalable.

Die in diesem Katalog wiedergegebenen technischen Daten können ohne Vorankündigung verändert werden.

Los datos técnicos indicados en este catálogo pueden ser modificados sin aviso previo.

